

---

## Operation, Sizing and Installation Manual

---

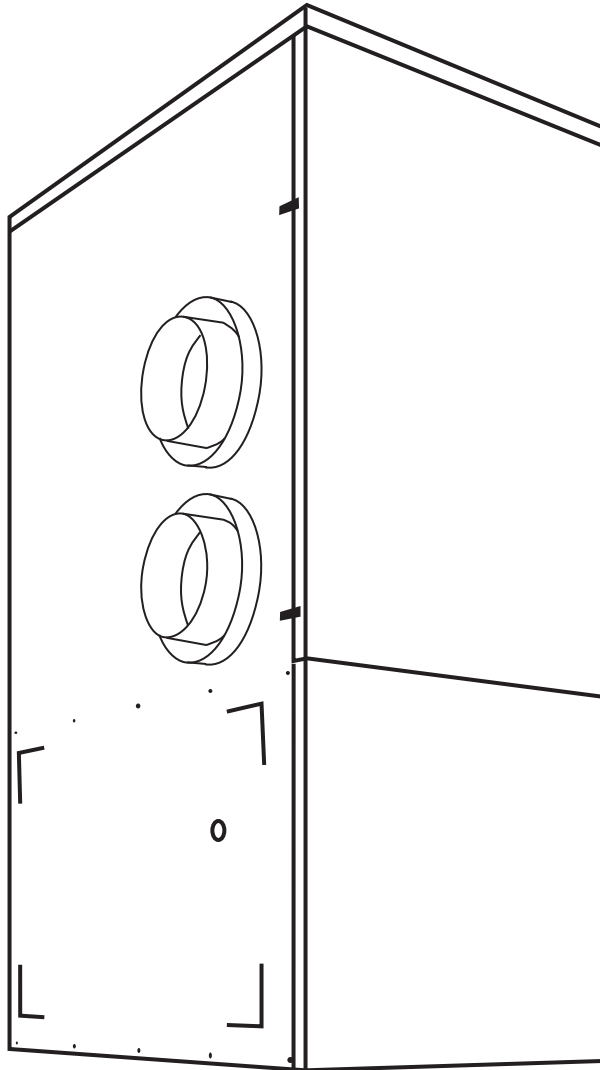

### Models

- CAF-U-S4A-24-P16 (E16)
- CAF-D-S4A-24-P16 (E16)
- CAF-U-L4A-36-P16 (E16)
- CAF-D-L4A-36-P16 (E16)
- CAF-U-L2A-48-P16 (E16)
- CAF-U-00-24-P16 (E16)
- CAF-U-00-36-P16 (E16)
- CAF-U-00-48-P16 (E16)

**Hydronic Models with Built-in  
Heat Recovery Ventilator (HRV)**

**CAUTION** 

Assess how the operation of an HRV/ERV may interact with already installed vented combustion equipment (ie. Gas Furnaces, Oil Furnaces, Wood Stoves, etc.).

**CAUTION** 

Never install an HRV/ERV in a situation where its normal operation, lack of operation or partial failure may result in the backdrafting or improper functioning of vented combustion equipment!

**! ATTENTION**

The Clean Air Furnace hydronic coil is not to be used for chilled water applications where condensation is expected.

**! ATTENTION**

Air Condition coil freezing can damage the hydronic coil of the Clean Air Furnace. Install a Freeze Thermostat Kit to your air conditioning coil to prevent coil freeze up. Check with your air conditioner distributor to obtain a Freeze Thermostat Kit.

**! ATTENTION**

Do not apply electrical power to the unit until installation has been fully completed (including low voltage control wiring).

**Table of Contents**

Introduction  
 Overview of the Clean Air Furnace .....3  
 Description and Purpose  
 Operation Heating/Cooling.....4  
 The Recovery Core .....5  
 Combo System Basic Principles .....6  
 Plumbing.....7-14  
 Installation .....15-17  
 Pitot Tube Air Flow Balancing .....18-19  
 Function and Controls .....20-21  
 Optional Dehumidistat  
 Optional Timer .....22  
 Wiring the Controls.....23  
 Aircom Relays .....24  
 Start-up Procedure .....25  
 Service and Maintenance .....26  
 Troubleshooting .....27  
 Controlling your HRV  
 How the Dehumidistat Works .....28  
 Model Number Nomenclature Breakdown.....29  
 Specifications .....30-37  
 System Commissioning .....38  
 Work Sheets .....39-40  
 Wiring Diagrams .....41-42

Register for your warranty at [www.lifebreath.com](http://www.lifebreath.com)

Airia will require the Model and Serial Number to register the unit.

**TO BE COMPLETED BY CONTRACTOR AFTER INSTALLATION**

---

Installing Contractor

---

Telephone / Contact

---

Serial Number

---

Installation Date Model

## Introduction

You will notice that the heated air in your home feels more comfortable than air heated by a conventional furnace. One reason for this is that LIFE BREATH's hydronically heated air is uniform and temperate... no short blasts of hot air or hot and cold temperature spikes. The air flowing from your hot air vents will not feel as hot to the touch as air from a conventional furnace.

With a high efficiency, **adequately sized** natural gas, propane or oil hot water heater/boiler, you will always have plenty of hot water for showers and baths, washing dishes and clothes, and all other normal domestic hot water needs. If there is an unusually high demand for hot water, such as filling a large hot tub, then all you need to do is allow more time for the task so the water heater/boiler can keep up to its job of providing hot water for the heating system as well as other household uses.

Once it is correctly installed, safety will never be an issue with your LIFE BREATH furnace. No flames, fumes or flue gases to be concerned about. Your domestic hot water heater/boiler now provides the heat source for your furnace.

This Operation and Installation Guide will help you learn about your LIFE BREATH Clean Air Furnace quickly and easily. The table of contents will show you where to find information on every feature of this unit along with easy to understand operating instructions. If, however, you do encounter a question that is not covered in this Guide you should call the LIFE BREATH dealer who installed your furnace. Chances are that he will be able to give you a satisfactory answer but if he is unable to do so then we invite you to contact us directly.

*Airia Brands Inc.*

## Overview of the Clean Air Furnace

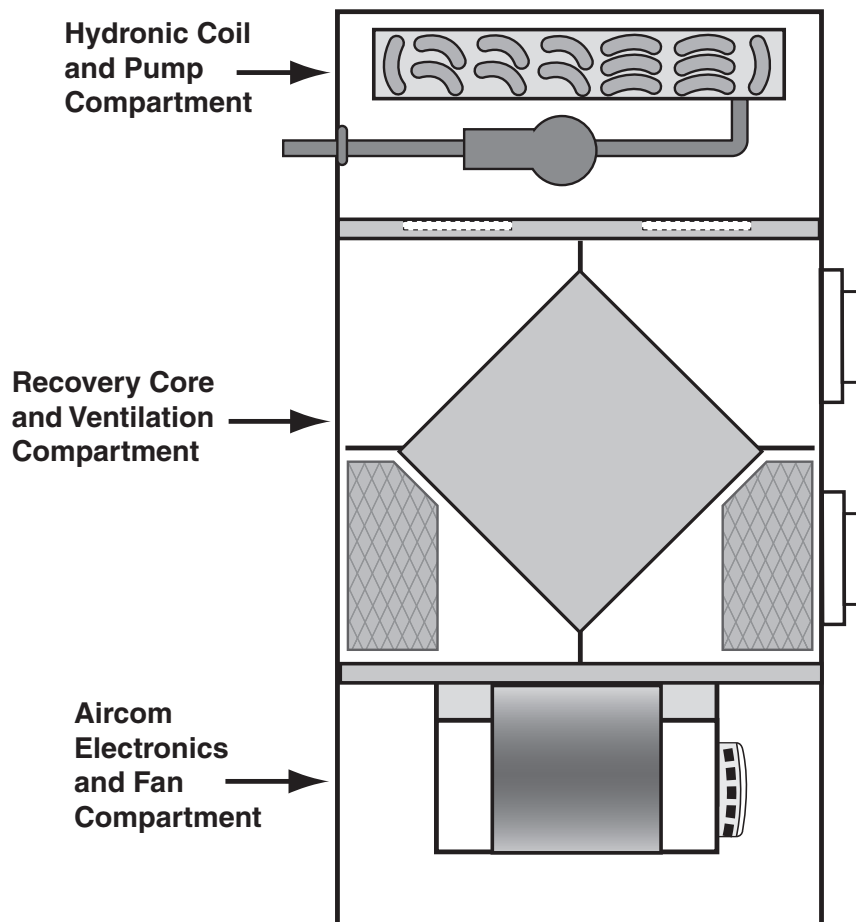

## Description and Purpose

### IMPORTANT NOTE

The purpose of this manual is to act as an installation guide only for the LIFE BREATH Clean Air Furnace. Manufacturers' instructions for other components, such as the water-heater/boiler, must be followed.

All national and local code requirements must be met when installing a LIFE BREATH Clean Air Furnace. Be sure to consult the proper authorities.

**Note: Temperatures greater than 130°F (54°C) pose a serious risk of scalding individuals running domestic hot water for potable use.**

This appliance complies with IAS Canada Inc. Requirement CR95-003, Additional Requirements for Fan Coil Units for use with Potable Water Heaters.

All piping and components connected to this appliance shall be suitable for use with potable water.

Toxic chemicals, such as used for boiler treatment, shall not be introduced into the potable water heater system.

When using this system and the hot water for space heating is set to a higher temperature than for other uses, an anti-scald valve shall be used to ensure water for common use is reduced in temperature to minimize a scalding hazard.

Combining two or more end uses such as space heating and the heating of domestic hot water in a single system has the potential to increase efficiency and reduce overall capital costs. However, the proper design, installation, and commissioning of these systems are critical if these advantages are to be realized.

This manual provides a guideline of good engineering practice in the design, installation and commissioning of Integrated Combo Systems. The guidelines in the manual are designed for residential forced warm air Integrated Combo Systems which utilize domestic water heaters or boilers and the LIFE BREATH furnace. Heating and cooling loads shall be calculated in accordance with recognized Residential Heat Loss and Heat Gain Calculation methods. Duct design shall comply with recognized Residential Air System Design methods. This manual provides worksheets to be used for the purpose of sizing residential water heaters and the combo furnace.

The LIFE BREATH Clean Air Furnace is a volume ventilation system. Use the optional Lifebreath Bathroom Exhaust System Kit (Part 99-CAF-BESKIT) if you wish to exhaust from specific locations such as bathrooms.

## Operation Heating/Cooling

When the room thermostat calls for heat, it activates a circulation pump located inside the Clean Air Furnace. This pump delivers hot water from the water heater, through the furnace coil and back to the water tank. Simultaneously, the furnace blower switches on to high speed and will start circulating air across the coil, which picks up heat and delivers it to the rest of your home.

Once the thermostat's temperature is reached the pump will shut off, and the blower will return to its pre-set speed or off.

**Note: When the furnace blower is left running on low speed the air in the home circulates continuously. When the heat is called for the blower will automatically switch to a higher speed. After the required hot air has been delivered the blower will switch back to low speed.**

When the thermostat calls for cooling (evaporator coil and condensing unit required), the furnace blower activates to high speed and the outdoor condenser unit is energized. After the thermostat temperature is reached, the condensing unit will shut off and the blower will return to its preset speed or off.

### Ventilation

The heat recovery ventilation (HRV) portion of the Clean Air Furnace, is automatic. Once set, a desired amount of fresh air will be drawn into the home while the furnace blower is activated.

To reduce humidity, increased ventilation may be required during heating season. An optional remote dehumidistat can be installed. The dehumidistat will increase the speed of the furnace blower to high and will return to its original setting when humidity levels decrease. Your dehumidistat must be switched off during warmer months. A quality humidifier should be added if you wish to increase winter humidity levels.

Typically the air flow for ventilation will be set to 50 - 70cfm, for low speed furnace operation, and 100 - 150cfm at high speed. The pleated furnace filter should be checked regularly and replaced as needed. The HRV filter should be washed twice a year or more often if needed.

### Off Season Circulation Timer

All models are equipped with a circulation timer. It is normal operation for these models to automatically run the circulation pump intermittently for a short period of time.

## The Recovery Core

### HRV - Aluminum Core

A Heat Recovery Ventilator (HRV) is designed to provide fresh air into a building while exhausting an equal amount of stale air. During the winter months, the incoming cold fresh air is warmed by utilizing the heat recovered from the stale air before it is exhausted to the outdoors. During summer months when the indoor space is air conditioned, the Heat Recovery Ventilator will help in cooling the incoming fresh air with the stale air that is being exhausted.

### ERV - Enthalpic Paper Core

An Energy Recovery Ventilator (ERV) is designed to provide fresh air into a building while exhausting an equal amount of stale air. An ERV is designed for use in warm humid areas with heavy air conditioning use. The ERV will transfer both sensible and latent heat from the incoming fresh air to the outgoing stale air thereby reducing the load (due to ventilation) on the air conditioning system.

## ! ATTENTION

The ERV - Enthalpic Core is not suitable for climates where the outdoor temperature drops below  $-4^{\circ}\text{C}$  ( $25^{\circ}\text{F}$ ).

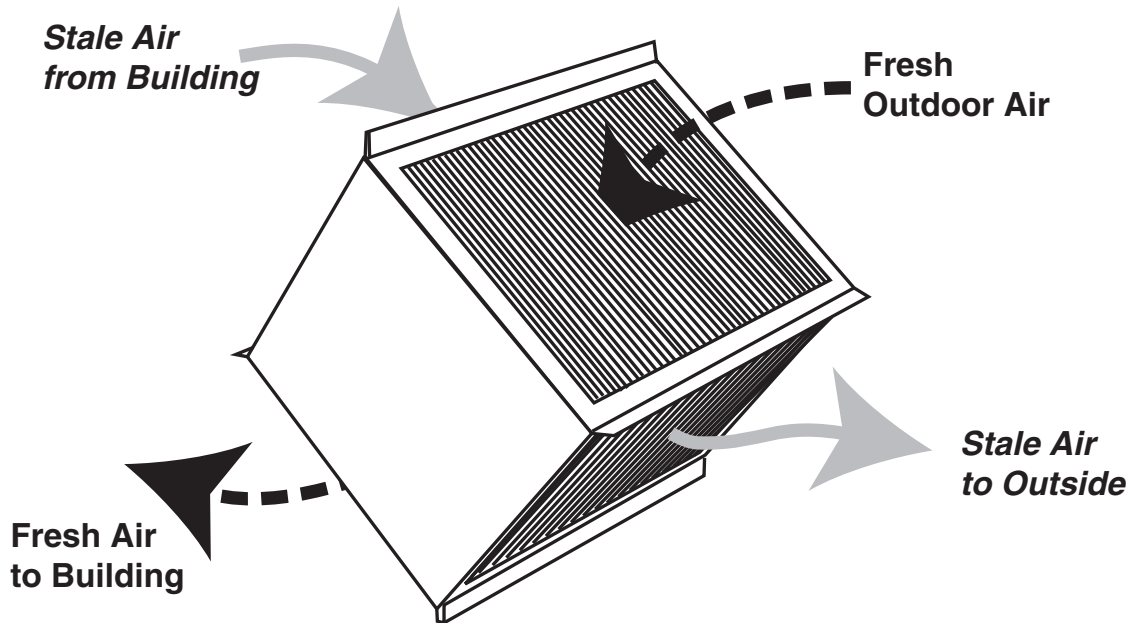

## Combo System Basic Principles

### Open and Closed Systems

Open and Closed systems both deliver hot water and space heating.

Water systems that incorporate a pressure tank (i.e. well systems) are normally Open Systems and most municipal water systems are Closed Systems.

## ! ATTENTION

**Check valves should always be installed in a vertical rise with the flow of water shown.**

### Drain Valve

A drain valve is required to allow the heating loop to be drained for service or repair and to remove air from the heating loop when commissioning a system. The drain valve should be near the low point of the return piping system to be near the water heater. Ball, Globe or Gate Valves are suitable for drain valves.

## IMPORTANT

Refer to local codes, local bylaws and installation manuals supplied with water heater before starting any installation work.

### Closed Loop System

A system becomes closed when a Check Valve or a back-flow prevention valve is installed in the cold water piping upstream of the water heater.

A check valve will prevent water being relieved into the cold water system due to pressure created when water is heated in the water heater.

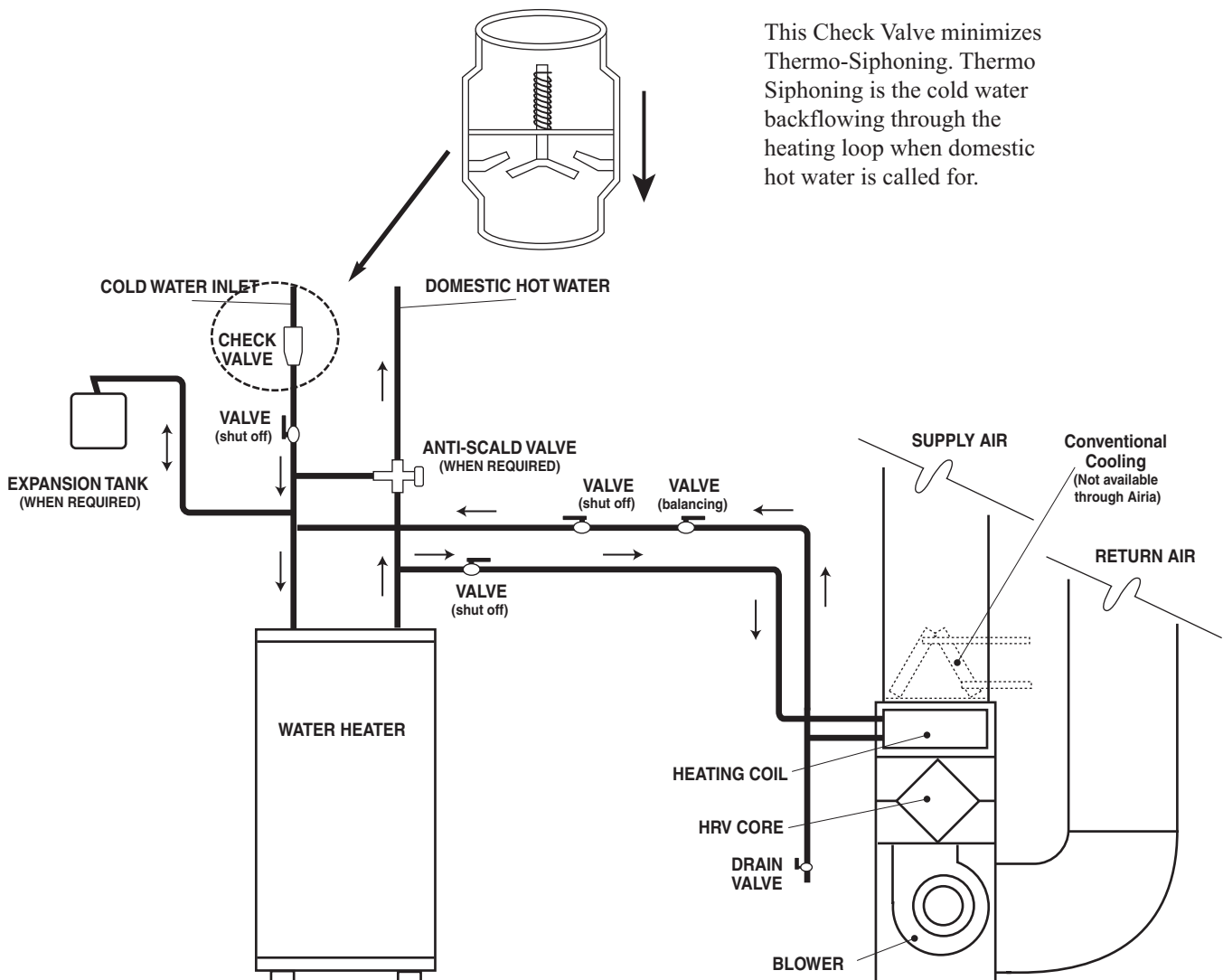

This Check Valve minimizes Thermo-Siphoning. Thermo Siphoning is the cold water backflowing through the heating loop when domestic hot water is called for.

## Plumbing

There is an integrated check valve in the CAF / AH unit.

**Note: Take care during soldering to avoid debris or solder from lodging in the check valve.**

**Note: It is critical to follow the piping configuration shown. Maintain a minimum distance of 12" above the CAF/AH. This will minimize thermal siphoning in the combo system.**

Figure 1

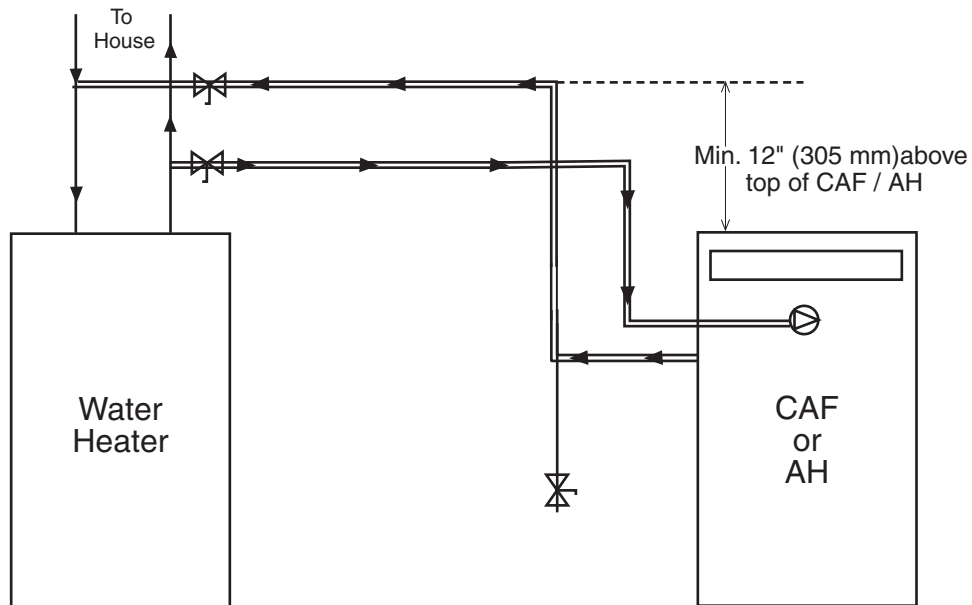
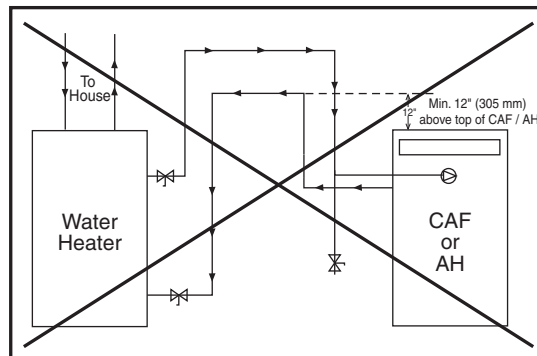

Figure 2



**\* It should be noted that problems have been observed when using the side tapplings on certain water heaters; therefore, it is strongly recommended to use the top water tapplings as indicated in Figure 1 to minimize thermal-siphoning and related issues.**

## Plumbing

### Expansion Tanks

Expansion tanks are required in addition to a Check Valve for Closed Systems because pressure is created when water is heated in the water heater.

The expansion tank has an air bladder which will contract to relieve pressure in the system. The tank should always be connected to the cold water piping between the water heater shut off valve and the cold water inlet to the water heater.

### Anti-Scald Valve

An anti-scald valve is required when the water heater thermostat is set above 140°F (60°C). Also, an anti-scald valve may be required for all installations by the “authority having jurisdiction”. The valve is placed in the hot water supply piping from the water heater downstream of the heating loop connection and upstream of any domestic hot water connection.

The purpose of the valve is to limit the maximum temperature available for domestic hot water by mixing hot water from the water heater with cold water from the municipal supply.

The Anti-Scald valve must be thermostatically controlled and approved to the ASSE standard No. 1016 and 1017 for use as an anti-scald device.

### Time to Scald

(1st degree burns)

Temperature	Time
120°F	8 min.
130°F	20 sec.
140°F	3 sec.
160°F	<1 sec.

### Closed Loop System

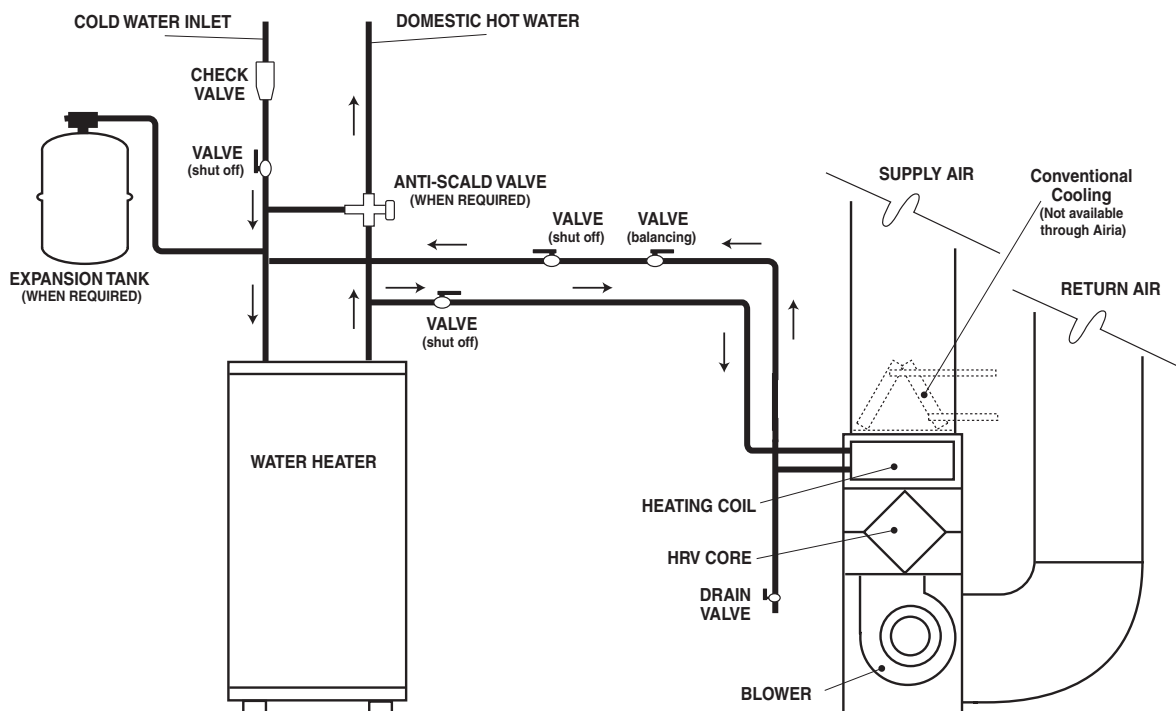



**Valves**

- (a) Located on the cold water side of the Heater.  
This valve has the ability to isolate the hot water (domestic and space heating) from the household cold water supply. Every water heater requires this valve regardless of space heating use.
- (b) Located on the hot water supply side of the heating loop, downstream of its connection to the domestic water.
- (c) Located on the return side of the heating loop upstream of its connection to the domestic cold water.

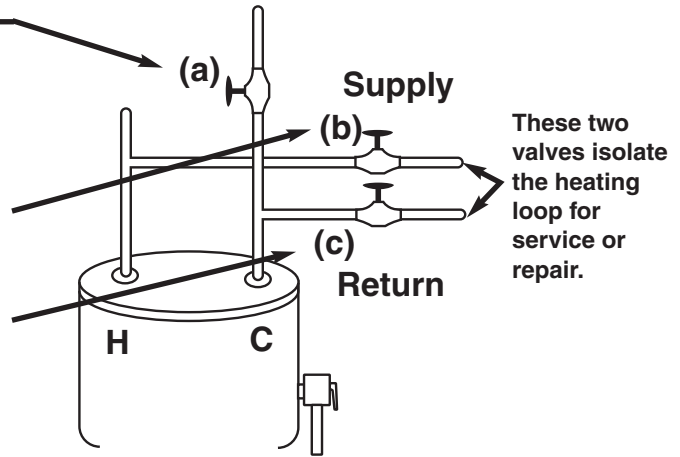

**Ball Valve**

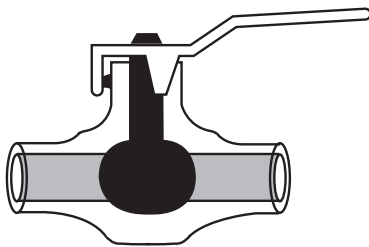

The Ball Valve can be used as a shut off or drain valve. When in the open position, a full bore ball valve has very little resistance to flow, and these valves tend to be both the least expensive and the least susceptible to seizing over time. Do not use reduced bore ball valves as they are very restrictive to water flow.

**Gate Valve**

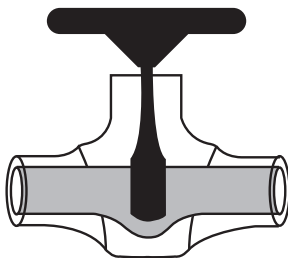

The Gate Valve can be used as a shut off or drain valve. When in the open position, there is very little resistance to flow. Gate valves tend to be less expensive than other types of valves but are susceptible to chatter (noise) and malfunction with age.

**Globe Valve**

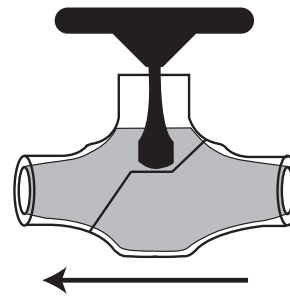

The Globe valve can be used as a shut off, drain or throttling valve. Even in the open position, the valve is fairly restrictive to flow. It has a much greater equivalent length (resistance.) than the other types of valves.

**Balancing (Throttling) Valve**

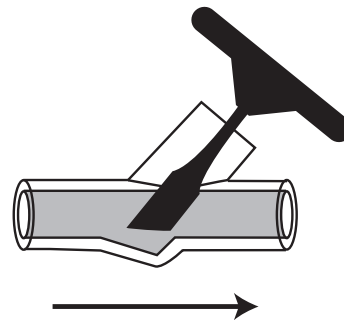

The Balancing (Throttling) Valve is used to reduce the water flow rate and thereby increase the water temperature drop. This is done to ensure proper activation of the water heater thermostat.

A Globe Valve could also be used for Balancing (Throttling) but has more resistance than the Balancing Valve.

## Plumbing

### Call for Space Heating

There are two thermostats controlling every combo system, the water heater thermostat (controlling the hot water temperature) and the room thermostat (controlling the room air temperature).

When the room thermostat calls for heat, the circulation pump is activated. Hot water is then drawn from the top of the water heater through the air handler, and then returned to the water heater.

### Open Loop System

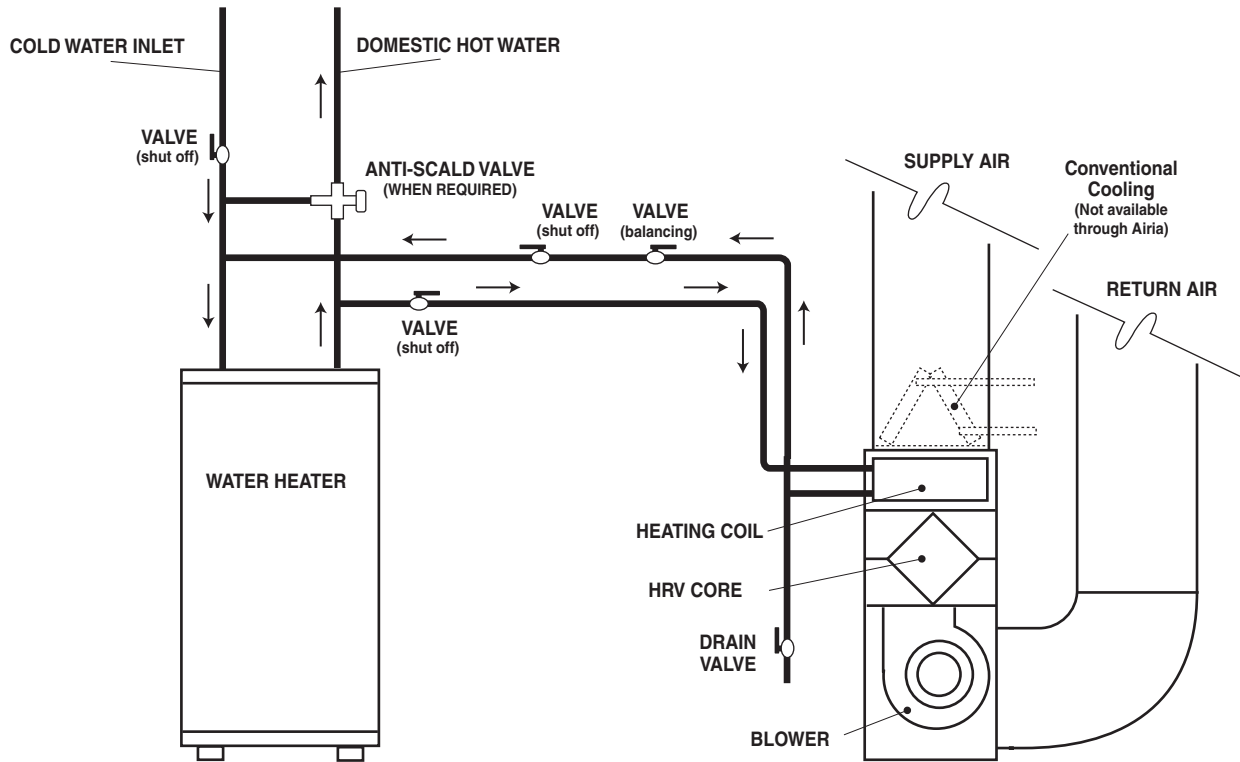

### Hot Water Temperature Drop

The water heater thermostat will initiate the water heater as required as long as there is a 20°F (11°C) temperature drop between the hot water supplied to the air handler and the returning water.

A temperature drop less than 20°F (11°C) can cause the water heater thermostat not to initiate. This will result in a lower hot water supply temperature or poor space heating performance with fluctuating domestic water temperatures.

### Call for Domestic Hot Water and Space Heating

When both return water from the space heating loop and new cold water (replacing domestic water being used) enters the water heater, the mixed entering water is cool enough to activate the thermostat quickly. In this situation, the water heater must be capable of satisfying the combined need for domestic hot water and space heating at the same time.

## ! ATTENTION

Plumbing components and system configuration may vary from diagrams portrayed.

## ! ATTENTION

Chemicals (such as boiler system additives) cannot be added to a domestic hot water system.

**Quick Connect Kit: PART# 99-CAF-PKit 1/2 or 3/4**

The pre-assembled, Quick Connect Kit shortens the installation time. It provides an instant, easy assembly of the major plumbing fittings required for a proper CAF/AH installation.

The Quick Connect Kit includes the WATER IN and WATER OUT assemblies. Kits are available in 1/2" and 3/4" sizes. Refer to the CAF/AH specification sheet located in the Operation and Installation Manual to obtain the correct size of water connections for the unit being installed.

Push-fit Fittings instantly make plumbing connections thereby eliminating the need for solder. Be sure to read the Push-fit Fitting Installation Instructions (included with the Quick Connect Fitting Kit) before making any connections.

**PART #99-CAF-PKit1/2**

The 1/2" assembled kit.

**PART #99-CAF-PKit3/4**

The 3/4" assembled kit.

**KIT CONTENTS**

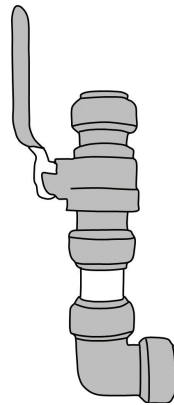

WATER IN Assembly

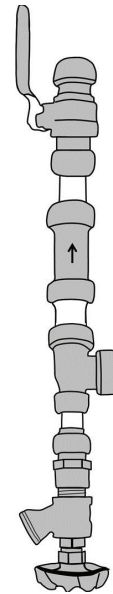

WATER OUT Assembly

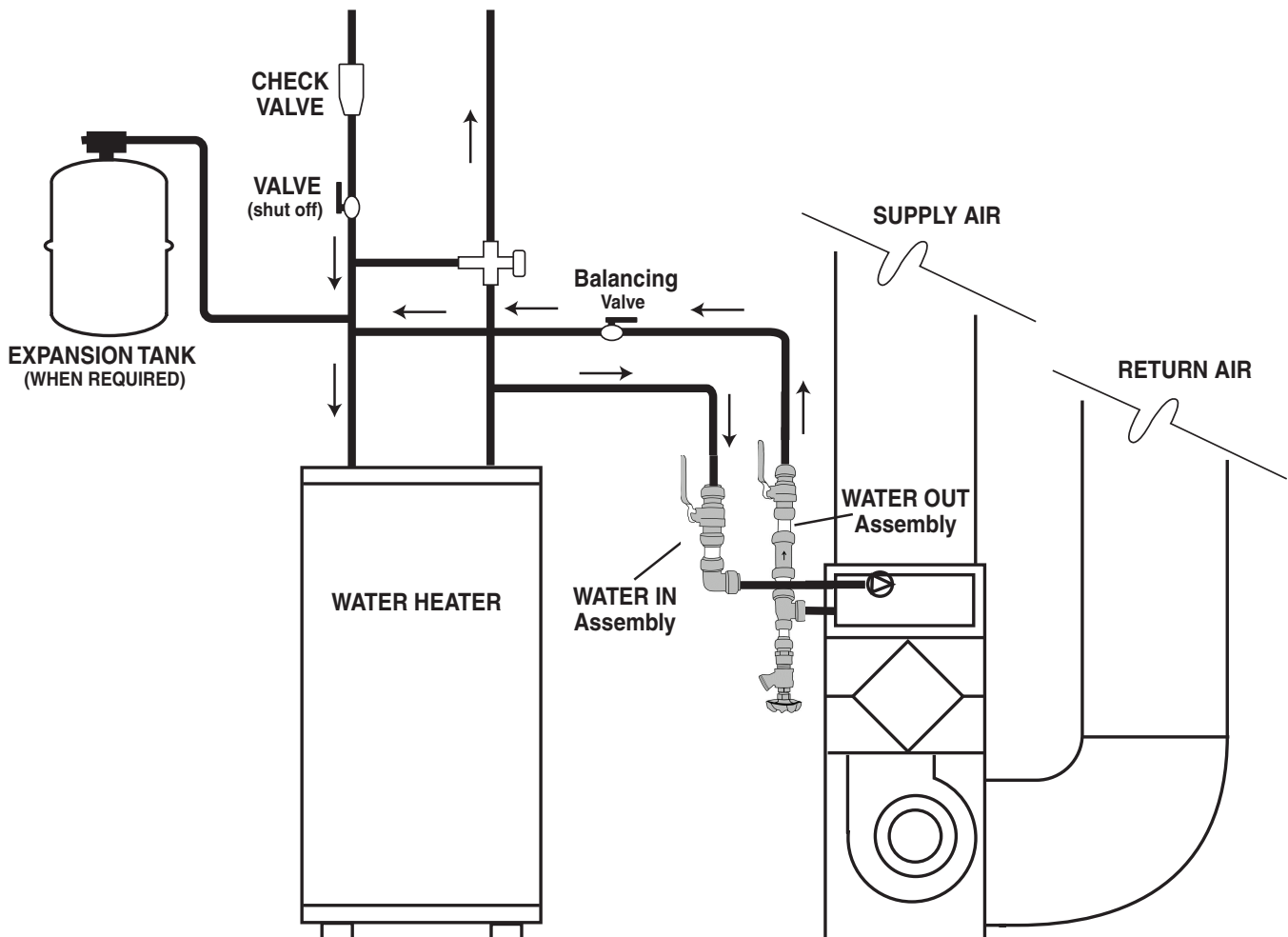

### Air System

A circulation fan draws cool house air at approx. 70°F (21°C) from the return ductwork, forces it through the water coil where it is heated, and then distributes it to the various rooms of the house through the supply ductwork.

### Water System Pressures

Within the water system of an Integrated Combo system, a designer/installer must understand the following terms:

1. Hot water supply temperature (EWT)
2. Hot water flow rate (GPM)
3. Air handler return temperature
4. Air handler flow rate (CFM)

### Head Pressure

Head pressure is the pressure created by the circulation pump to push water through the piping system. It is this pressure which is used to overcome the resistance to water flow (friction) caused by the water pipe and fittings. It is similar in concept to the external static pressure in an air duct system. Head pressure is measured in feet of water (millimeters of water).

**NOTE**

The vertical height of the heating loop does not impact on the head pressure as the pressure required to push the water up the vertical height is offset by the weight of the water in the vertical drop on the other side of the heating loop.

### Water Flow Rate

Water flow rate is the amount of water flowing in the system. It is directly related to the head pressure and the resistance to flow. Flow rate is measured in gallons per minute (liters per minute).

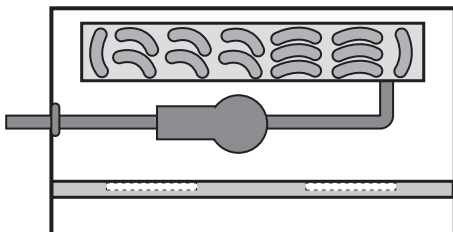

The circulation pump is factory installed within the air handler. The water flow rate will vary depending on the pumps performance and the head pressure (resistance) of the complete heating loop system.

The piping and fittings used to connect the water heater and air handler must be sized to handle the volume of hot water required by the air handler within the pressure limitations of the circulation pump. All piping, fittings solders, and fluxes must be acceptable for use with domestic hot water.

### Pressure Drop (PD)

Pressure drop (PD) is the reduction in total pressure caused by components added to a piping system such as coils, valves, and fittings. The measurement of pressure drop is the difference in pressure on the inlet side of the component and the outlet side. Pressure drop is measured in feet of water (millimeters of water).

When connecting the water lines for heating loop (air handler) to the domestic water system, the pipes should be connected with a “tee” to the side of a vertical domestic water pipe or the bottom of a horizontal domestic water pipe. This is to help prevent air from entering the heating loop. The connections should be as near as practical to the water heater.

### Water Pump Performance Specifications

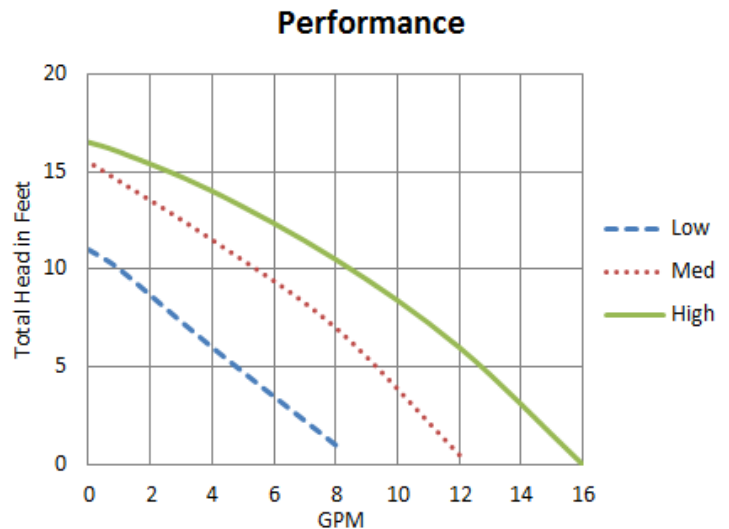

### Air Handler Output Capacity

There are four factors that will significantly affect the heating output of the air handler.

They are:

- Hot water supply temperature (EWT)
- Hot water flow rate (GPM)
- Air Handler return air temperature
- Air Handler air flow rate (CFM)

### Hot Water Supply Temperature

The hot water supply temperature is controlled by the water heater thermostat. This is set by the installing contractor to provide the required temperature at the hot water outlet of the water heater.

The hot water supply temperature is typically 140°F (60°C). If this temperature must be increased to achieve higher outputs from the furnace an anti-scald valve must be used to prevent domestic hot water temperatures above 140°F (60°C). The manufacturer of the Hot water Tank should be consulted for temperatures higher than 140°F.

It is important that a warning label be placed near the water heater thermostat telling the homeowner not to change the thermostat setting. The label is included with the furnace.

### Hot Water Flow Rate

The hot water entering the water coil is the source of heat to the air handler. The effect of changing the amount of water entering the coil is the same as changing the water temperature. As water flow is reduced, the output of the air handler and the air temperature rise will both be lowered.

### Air Handler Return Air Temperature

The return air temperature entering the air handler is approx. 60°F (33°C) below the hot water inlet temperature. If the return air temperature entering the air handler is reduced, more heat transfer will occur and the output of the air handler will increase.

#### NOTE

Although the water in the combo system is pressurized by the domestic water system, the pump is required to create water flow in the heating loop. The domestic water system applies the same pressure to the supply and return sides of the heating loop.

### Air Handler Air Flow Rate

The air entering the air handler can only be warmed by the temperature difference between the hot water and the cool air. As the volume (CFM (L/s)) of air is reduced, the amount of heat which can be transferred is also reduced.

### Air Handler Temperature Rise

In a fuel fired furnace, the combustion gases can be 1000°F (538°C) above the return air temperature. These units typically have a temperature rise from 50°F (10°C) to 90°F (32°C) and therefore delivers air at the diffuser at 120°F (49°C) to 160°F (71°C).

With an Integrated Combo System, the hot water temperature is approx. 130°F (54°C) which is 60°F (15.5°C) above the return air temperature. These units typically have a temperature rise of 35°F (2°C) to 40°F (4°C) and therefore would deliver air at the diffuser at approximately 105°F (40.5°C) to 110°F (43°C).

### Room Thermostat

The room thermostat controls both the water circulation pump and the air circulation fan. It should be on a centrally located, inside wall away from any source of heat such as diffusers, appliances and direct sunlight.

### Energy Saving Room Thermostat

A set back thermostat or “smart stat” can be used with a combo system, but care must be taken in the timing of the temperature changes. The timing of morning warm up should be early enough that the desired air temperature has been reached before the people begin to use domestic hot water. The highest demand for space heating is during the morning warm up and the highest demand for domestic hot water is during morning showers. Even if the water heater is properly sized, it may not be able to meet this combined load. Therefore, large set backs should be avoided.

### Design vs. Field Conditions

The factors discussed between design parameters and actual field conditions can impact greatly on output capacity. Therefore, it is important to do a thorough and complete commissioning of the integrated combo system to ensure the design parameters are met.

## Plumbing

### Drain Line

The ventilation portion of the Clean Air Furnace has two drain pans for removing condensation, which may occur on the heat recovery core during cold weather.

### Piping

The hot water piping between the hot water tank and the Clean Air Furnace should be new copper type, and should not be treated with chemicals, sealant or anything else, that will interfere with the purity of the potable water. Only non-lead, low temperature solder is permitted for sealing copper joints.

Where possible the length of pipe should not exceed 200' total equivalent length. Any piping running through unconditioned space must be insulated to prevent heat loss, and possible freezing of the line.

Look inside the furnace and locate the pump. Attach the "Hot Water In" (Supply) to the pipe running to the pump. Attach the "Hot Water Out" (Return) to the pipe running to the coil. Do not reverse these lines, as this will cause the unit to malfunction.

For piping conventional water heaters, connections to and from the Clean Air Furnace to the water tank should be made at the point where the pipes leave the tank vertically. A "T" fitting used in each vertical line, with the Clean Air Furnace piping connected to the horizontal side of this fitting, will work best in avoiding air locks in the circulation pump of the furnace.

**\*Note: Remove shipping block from underneath pump and discard.**

### HRV Drain Line Diagram

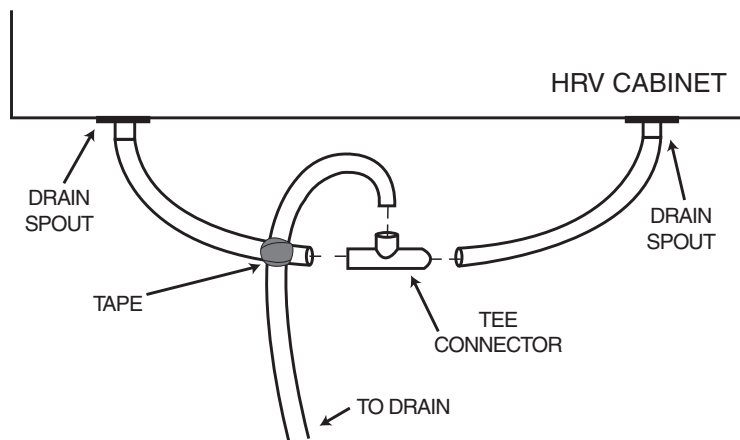

## Installation

This manual gives the contractor guidelines for installing the LIFE BREATH Clean Air Furnace. All national and local codes relating to this type of equipment must be followed.

### Locating The Unit

The Clean Air Furnace is designed to be installed vertically, in a conditioned space, **where the surrounding temperature does not fall below 50°F (10°C)**. Attic installations are not recommended.

Typically the unit is installed in a mechanical area of the basement, or other partitioned mechanical room, elsewhere in the home.

A location close to an outside wall is recommended, as the ventilation supply and exhaust portion will need to be ducted to the outside air. Sufficient clearance around the unit is required for service of the filter, heat recovery core and components. As a rule this unit should be installed adjacent to the hot water heater. If this is not possible, or if the piping layout is complex, the total head pressure on the pump should be calculated.

### Duct Connections

To accommodate various installations, the Clean Air Furnace has knockouts for the return air plenum and ventilation ducts, on both sides of the cabinet. Special care and attention should be given to determining which knockouts are to be removed.

Slide Heat Recovery Core out to remove ventilation knockouts. Never install ductwork directly to the cabinet that is smaller than the opening provided.

Penetrations from sheet metal screws used to fasten the ductwork to the cabinet of the unit should only be placed into the duct flange provided. This is to avoid contact and damage of the heating/air conditioning coils and internal wiring.

### Option 1 - Upflow Models

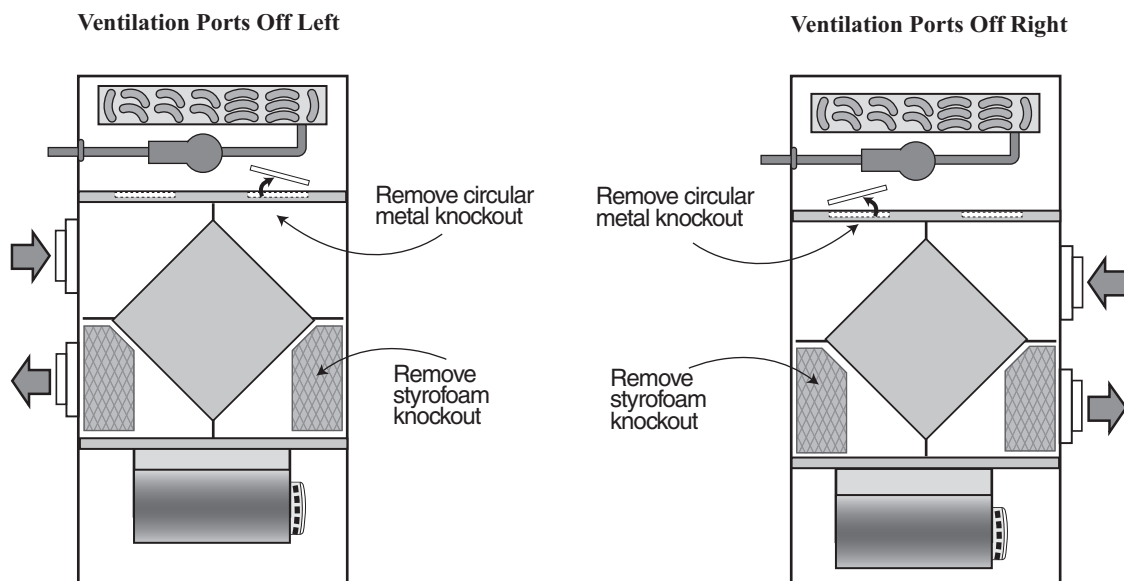

**NOTE:** Return plenum opening can be on either side of cabinet and is not dependent on which side the ventilation ports are on.

## ! ATTENTION

Do not remove circular knockout when installing the optional Bathroom Exhaust System (Part 99-CAF-BESKIT). Refer to instructions with kit.

## Installation

### Option 2 - Downflow Models

Ventilation Ports Off Left

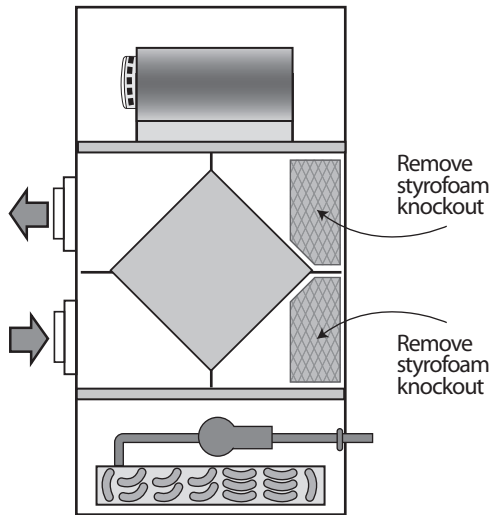

Ventilation Ports Off Right

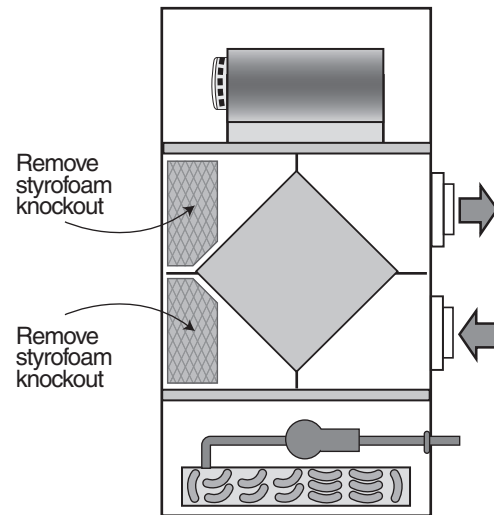

## ! ATTENTION

Do not remove lower styrofoam knockout when installing the optional Bathroom Exhaust System (Part 99-CAF-BESKIT). Refer to instructions with kit.

### Ducting

The duct sizing for the furnace section can be determined using HRAI Residential Air System Design Manual, SMACNA, or any other industry-recognized manuals.

**Note:** "Combo units" normally deliver air at approx. 110°F (43°C), and therefore may require larger than normal ductwork. When installing the Clean Air Furnace as a replacement unit on a retrofit application, always calculate the size of duct that is there.

Any ductwork running through unconditioned space must be sealed properly and insulated to prevent heat loss. All local codes must be followed in determining the amount of insulation needed.

The ventilation section consists of two 6" (15.2cm) round ports located on the side of the cabinet, which vent to the outside. Insulated ducting with a vapor barrier such as flex-ducting, or ridged pipe wrapped in pipe sleeve, is required to prevent condensation from occurring on the pipe. Also the airflow in these lines is designed to be balanced. (See "Balancing Airflows" in this manual, for damper location and procedure).

## ! WARNING

A Backdraft Damper is required in the exhaust air duct to prevent cold air from entering the unit when the Clean Air Furnace is not running.



## Installation

### Locating Intake Weatherhood

The intake weatherhood should be located as follows:

- 4 - 6' from ventilation exhaust hood, and upstream of prevailing winds, if possible.
- At least 6' from a dryer vent, oil fill pipes, combustion outlets, gas meters, garbage containers or anything else, which may contaminate the air.
- Do not locate fresh air intake in garages, crawl spaces or attics.
- Install 18" (45.72 cm) above grade, or above expected snow accumulation.

### Locating the Exhaust Weatherhoods

The Exhaust Weatherhood should be located as follows:

- At least 4-6' from the supply inlet
- At least 18" (45.72 cm) above grade or expected snow accumulation
- At least 3' from gas meters, combustion vents, or dryer vents
- Do not install in garages, crawl spaces or attics

### Outside Ducting the Weatherhoods

The ventilation portion of the Clean Air Furnace can be vented off either side of the unit by removing knockouts provided. Once the knockouts in are removed, a bead of silicone can be placed on the plastic thermo-collars (provided), to form a seal between the collars and the

## ! ATTENTION

Design and install the fresh air intake in an area where the hoods will gather the freshest air.

cabinet. The collars can then be fastened into place with screws. Note the exhaust outlet is always the port on the bottom, and the supply inlet is always the port on the top, both ports should be labeled from the factory as such.

The ductwork from the outside weatherhoods to the unit, is usually flexible ducting, although rigid pipe may be needed if the runs are greater than 10 feet. In either case the pipes (both exhaust and supply and the added fittings) must be insulated, with a complete vapor barrier.

To minimize restriction in airflows the ducting should be short, with as few bends as possible. See diagram below for recommended connection of insulated ducting to outside weatherhoods.

It is necessary to have balanced air flows in an HRV. The volume of air brought in from the outside must equal the volume of air exhausted by the unit. If the air flows are not properly balanced then:

- The HRV may not operate at its maximum efficiency
- A negative or positive air pressure may occur in the house
- The unit may not defrost properly
- Failure to balance the HRV may void warranty

## Locating Weatherhood

### WEATHERHOOD INSTALLATION

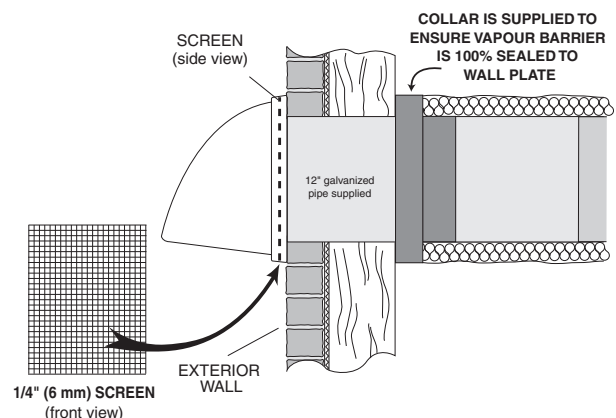

1. Thermal Collar slides over galvanized sleeve of Weatherhood.
2. Fasten Thermal Collar to Belt.
3. Slide the Insulated Flexible Ducting over the Weatherhood's galvanized sleeve and fasten it to the Thermal Collar.
4. Hood is hinged to allow for easy access for cleaning of bird screen.

## Pitot Tube Air Flow Balancing

It is necessary to have balanced air flows in an HRV. The volume of air brought in from the outside must equal the volume of air exhausted by the unit. If the air flows are not properly balanced, then;

- The HRV may not operate at its maximum efficiency
- A negative or positive air pressure may occur in the building
- The unit may not defrost properly
- Failure to balance HRV properly may void warranty

**Excessive positive pressure** may drive moist indoor air into the external walls of the building where it may condense (in cold weather) and degrade structural components. May also cause key holes to freeze up.

**Excessive negative pressure** may have several undesirable effects. In some geographic locations, soil gases such as methane and radon gas may be drawn into the home through basement/ground contact areas. Excessive negative pressure may also cause the backdrafting of vented combustion equipment.

**Read the Application Warning on the front of this manual!**

### Prior to balancing, ensure that:

1. All sealing of the ductwork system has been completed.
2. All of the HRV's components are in place and functioning properly.
3. Balancing dampers are fully open.
4. Unit is on HIGH speed.
5. Air flows in branch lines to specific areas of the house should be adjusted first prior to balancing the unit. A smoke pencil used at the grilles is a good indicator of each branch line's relative air flow.
6. After taking readings of both the stale air to the HRV duct and fresh air to the house duct, the duct with the lower CFM ([L/s] velocity) reading should be left alone, while the duct with the higher reading should be adjusted back to match the lower reading. See **Adjusting the Airflow**.
7. Return unit to appropriate fan speed for normal operation

### BALANCING PROCEDURE

The following is a method of field balancing an HRV using a Pitot tube, advantageous in situations when flow stations are not installed in the ductwork. Procedure should be performed with the HRV on high speed.

The first step is to operate **all** mechanical systems on **high speed**, which have an influence on the ventilation system, i.e. the HRV itself and the forced air furnace or air handler if applicable. This will provide the maximum pressure that the HRV will need to overcome, and allow for a more accurate balance of the unit.

Drill a small hole in the duct (about 3/16"), three feet downstream of any elbows or bends, and one foot upstream of any elbows or bends. These are recommended distances but the actual installation may limit the amount of straight duct.

The Pitot tube should be connected to a manometer capable of reading 3 digits of resolution. The tube coming out of the top of the pitot is connected to the high pressure side of the gauge. The tube coming out of the side of the pitot is connected to the low pressure or reference side of the gauge.

Insert the Pitot tube into the duct; pointing the tip into the airflow.

For general balancing it is sufficient to move the pitot tube around in the duct and take an average or typical reading. Repeat this procedure in the other (supply or return) duct. Determine which duct has the highest airflow (highest reading on the manometer). Adjust the higher airflow by reducing the fan speed (see "Adjusting the Airflow"). The flows should now be balanced. Actual airflow can be determined from the gauge reading. The value read on the gauge is called the velocity pressure. The Pitot tube comes with a chart that will give the air flow velocity based on the velocity pressure indicated by the gauge. This velocity will be in either feet per minute or meters per second. To determine the actual airflow, the velocity is multiplied by the cross sectional area of the duct being measured.

This is an example for determining the airflow in a 6" duct.

The Pitot tube reading was 0.025 inches of water.

From the chart, this is 640 feet per minute.

The 6" duct has a cross sectional area of

$$= [3.14 \times (6" \div 12)^2] \div 4$$

$$= 0.2 \text{ square feet}$$

The airflow is then:

$$640 \text{ ft./min.} \times 0.2 \text{ square feet} = 128 \text{ cfm}$$

For your convenience, the cross sectional area of some common round duct is listed below:

DUCT DIAM. (inches)	CROSS SECTION AREA (sq. ft.)
5 (127 mm)	0.14
6 (152 mm)	0.20
7 (178 mm)	0.27

The accuracy of the air flow reading will be affected by how close to any elbows or bends the readings are taken. Accuracy can be increased by taking an average of multiple readings as outlined in the literature supplied with the Pitot tube.

### Pitot tube and gauge

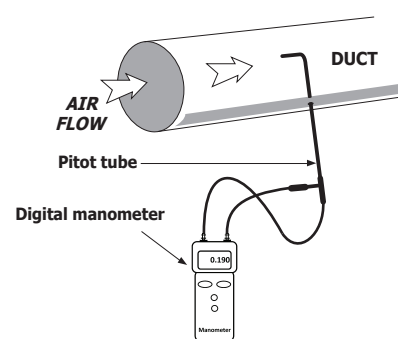

**Pitot Tube Air Flow Balancing Kit**  
c/w digital manometer, Pitot tube, hose and tool bag.  
PART NO. 99-BAL-KIT

Figure B

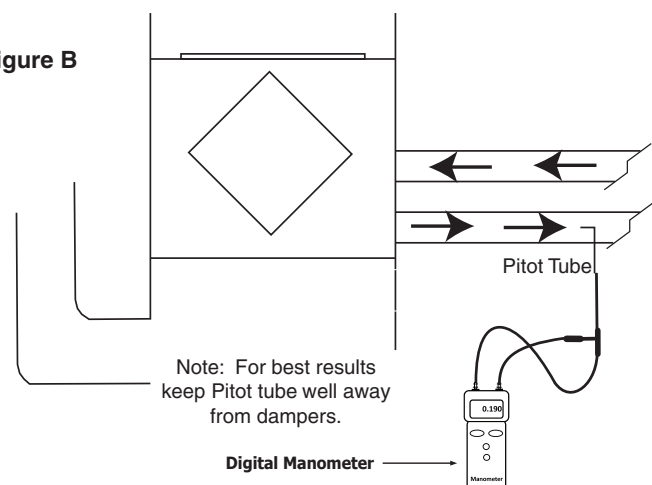

## Pitot Tube Air Flow Balancing

The accuracy of the airflow reading will be affected by how close to any elbows or bends the readings are taken. Accuracy can be increased by taking an average of multiple readings as outlined in the literature supplied with the Pitot tube.

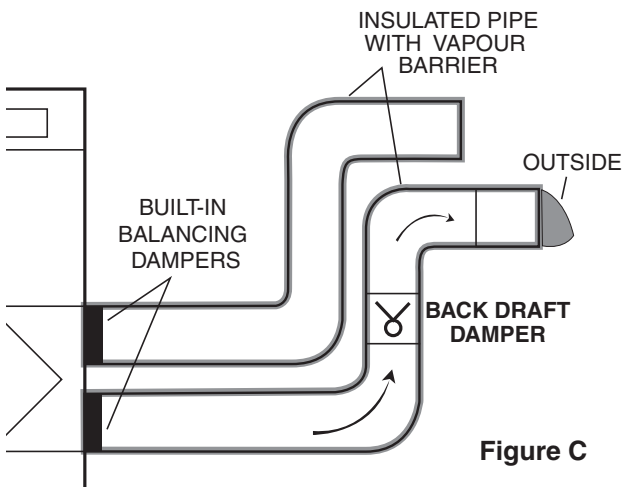

Figure C

### Back Draft Damper

The back draft damper (not included) can be located anywhere in a vertical rise of the exhaust duct.

## **! WARNING**

**A Backdraft Damper is required in the exhaust air duct to prevent cold air from entering the unit when the Clean Air Furnace is not running.**

### Balancing Collar Instructions

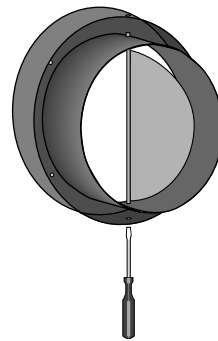

Push and turn with slotted screwdriver. Damper automatically locks when pressure is released.

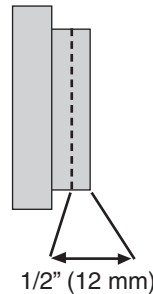
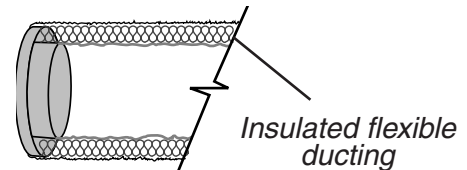

When connecting ductwork to the collar, take note where screws are located. Screws should be located no further than 1/2" (12.70 mm) from outside edge of collar, so as not to impede operation of the damper.

Figure D

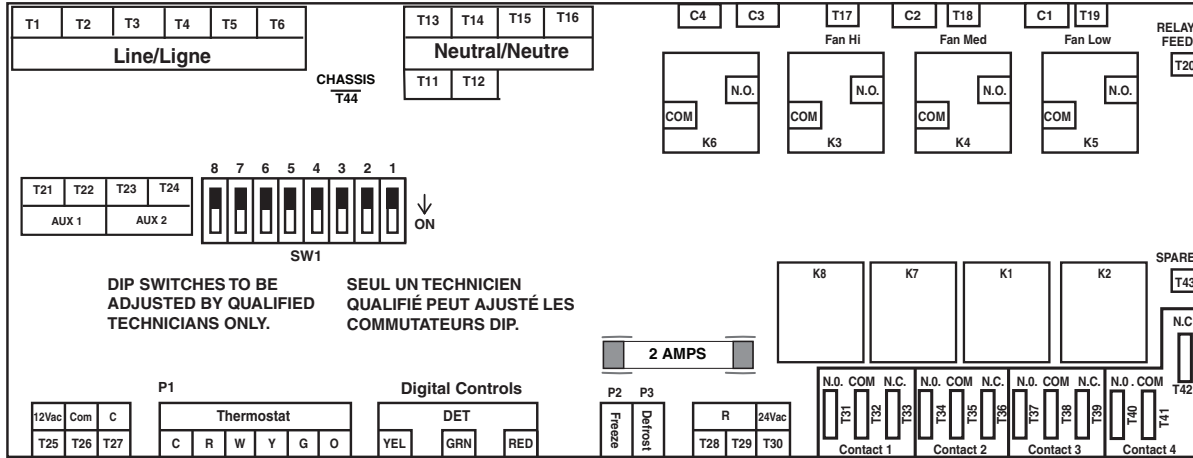

**Standard 24 Volt Thermostat Connection**

(Thermostats are not available through Airia)

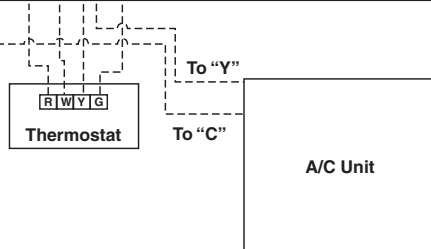

**Thermostat Heat Anticipator Settings**

Mechanical Thermostats - start at .5 amp and may need to be increased depending upon the residual heat left in the hydronic coil and duct work.

Electronic Thermostats - to be set on electric style heat.

**Off Season Circulation Timer**

Water is periodically circulated through the space heating loop during the summer and other periods of infrequent use. The concern is that water which remains stationary in the heating loop during the summer may be less than desirable as domestic hot water when it is returned to the water heater at system startup in the fall.

**Standard Motor DIP Switch Settings (DIP #1-8 OFF is Factory Setting)**

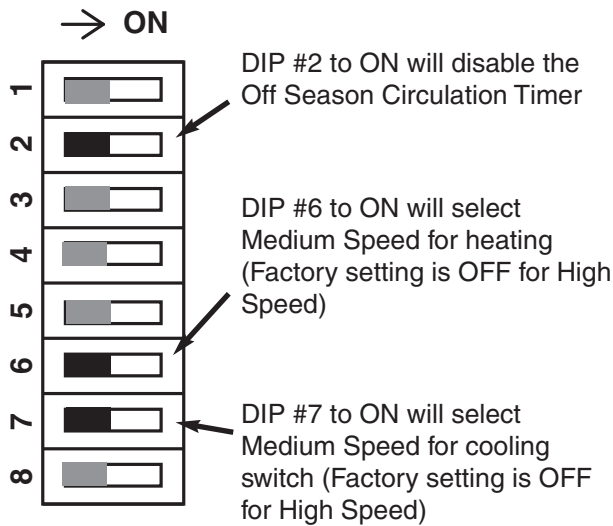

**! WARNING**

**Do not energize the CAF until the plumbing is connected and commissioned. Failure to do so will damage the pump.**

**Basic Functions**

- C - Common
- R - 24 volt Supply
- W - Medium or High Fan Relay with Circulation Pump (The speed depends on Dip Switch # 6 setting)
- Y&G- Medium or High Fan Relay (The speed depends on Dip Switch # 7 setting)
- G - Low Speed Fan Relay
- O - High Speed Fan Relay with Circulation Pump

**! WARNING**

**Do not adjust any other DIP switches than indicated above.**

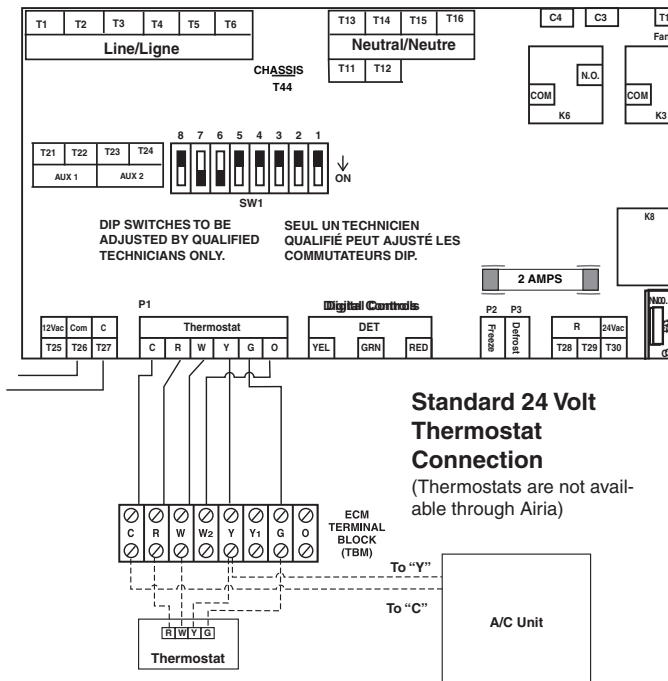

**Thermostat Heat Anticipator Settings**

Mechanical Thermostats - start at .5 amp and may need to be increased depending upon the residual heat left in the hydronic coil and duct work.

Electronic Thermostats - to be set on electric style heat.

**ECM Motor DIP Switch Settings**  
(DIP 6&7 ON is Factory Setting)

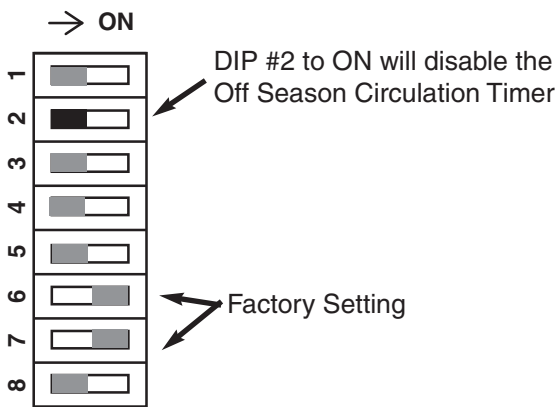

**Basic Functions**

- Thermostat fan switch will control low speed fan operation
- Call for heating - high speed
- Call for cooling - high speed

**ECM Motor DIP Switch Settings**

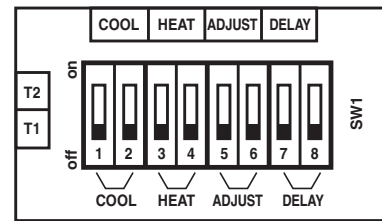

Switch Setting	Fan Speeds
Cool Switches	Cool
Both OFF	High
1 ON - 2 OFF	Med High
1 OFF - 2 ON	Med Low
1 ON - 2 ON	Low

Switch Setting	Fan Speeds
Heat Switches	Heat
Both OFF	High
3 ON - 4 OFF	Med High
3 OFF - 4 ON	Med Low
3 ON - 4 ON	Low

Switch Setting	Fan Speeds	
Adjust Switches	Heat	Cool
Both OFF	Normal	Normal
5 ON - 6 OFF	Increase 15%	Increase 15%
5 OFF - 6 ON	Decrease 15%	Decrease 15%
5 ON - 6 ON	Normal	Normal

Delay Switches are for future use - no function at this time

**Note:** Refer to individual specification pages for Airflow Performance specifications. Above settings correspond to DIP switch settings on the ECM circuit board only. Do not adjust DIP switches on MAIN Circuit Board.

**⚠ WARNING**

Do not energize the CAF until the plumbing is connected and commissioned. Failure to do so will damage the pump.

**⚠ WARNING**

Do not adjust any other DIP switches than indicated above.

**⚠ ATTENTION**

DIP switches #6 & #7 must be ON for the ECM motor to function (factory setting).

## Optional Dehumidistat - Part #99-DH-01

### Key Features

- The Dehumidistat measures the indoor humidity level and will initiate high speed ventilation when the moisture level in the building exceeds the set point on the control.
- Once the humidity in the building is reduced, the unit will revert to its previous setting.
- The Dehumidistat should be set to OFF for all season except the heating season.
- Connect to 3 wire 20 gauge low voltage wire.

### Humidity Control

Your HRV will produce a dehumidifying effect when outdoor humidity levels are lower than indoor humidity levels. Never use the dehumidistat feature when outdoor temperatures are above 59 F (15 C).

Note: The indoor humidity level is measured at the control.

### Setting the Dehumidistat

Press and release the DEHUMIDISTAT button until the DEHUMIDISTAT LIGHT is at the desired setting. After 5 seconds the dehumidistat light will either flash or be on continuous.

A flashing light indicates the humidity level is higher than the setting and the unit is operating on high speed ventilation. A continuous light indicates the humidity level is lower than the setting. Connect to 3 wire 20 gauge low voltage wire. Mounts in a standard 2" x 4" electrical box.

Note - Only 1 dehumidistat should be active on a system.

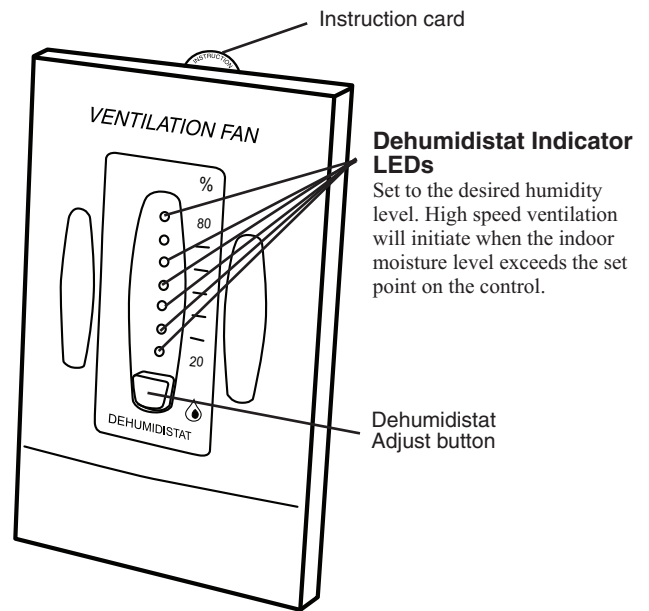

## Optional Timer

The timer will override the Operational Mode (regardless of the settings) and initiate high speed ventilation. Upon completion of the timer cycle, the HRV will return to your selected Operational Mode and speed setting.

### Lifestyle 20/40/60 Minute Timer

#### Part # 99-DET01

Initiates high speed ventilation for 20, 40 or 60 minutes. The 20/40/60 Minute Status Lights indicate high speed operation.

Lockout Mode is useful if you wish to disable the timer. Set lockout by holding the Select Button for 5 seconds. Unlock by holding for 5 seconds.

Connect to 3 wire 20 gauge low voltage wire. Mounts in a standard 2" x 4" electrical box.

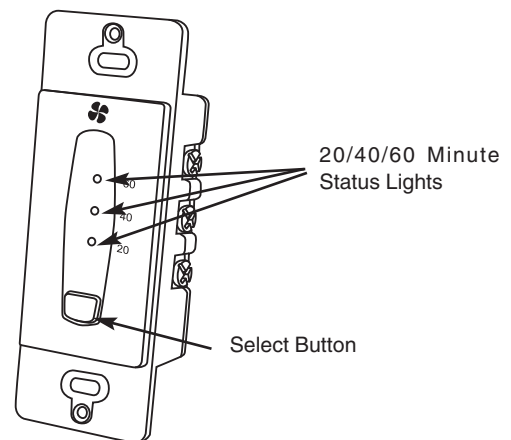

# Wiring the Controls

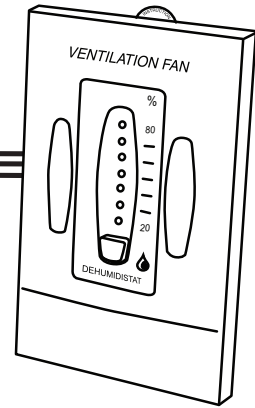
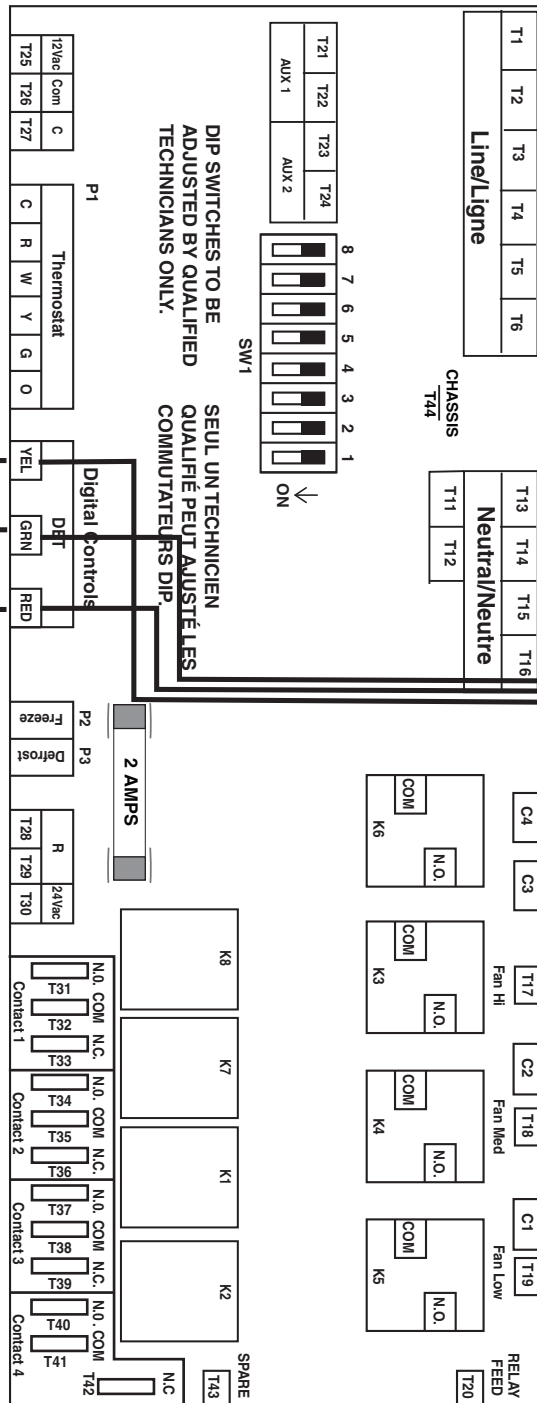

## Optional Dehumidistat

Connect to Yellow, Red & Green

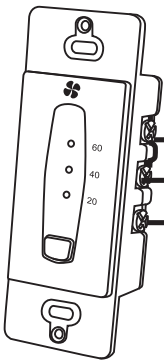

## Optional Timers

Connect to Yellow, Red & Green

## Aircom Relays

The Aircom circuit board has three available “dry contact” relays. Contact 3 is not available.

Maximum 115V 10 amp resistive load.

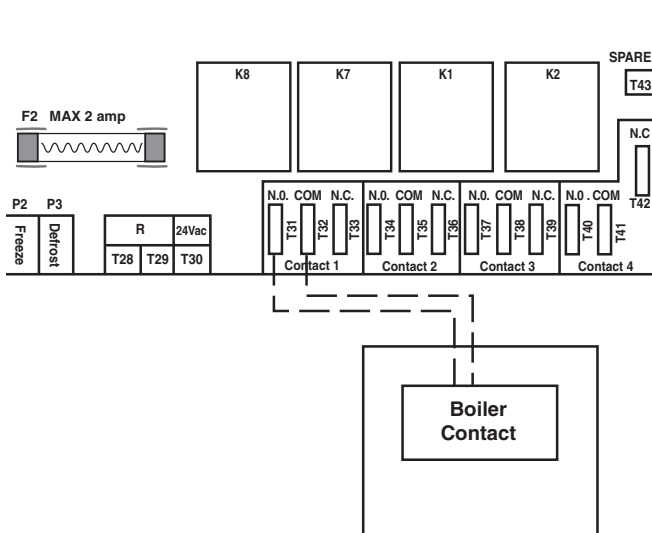

### Contact 1

This relay is a dry contact (no power supplied from board). The relay switches states upon a call for heat.

This relay can be used to switch the heat demand signal for boiler operation.

Power (if required) must be supplied to common from an external source.

Max. voltage - 120 volts

Max. Amperage - 10 amps

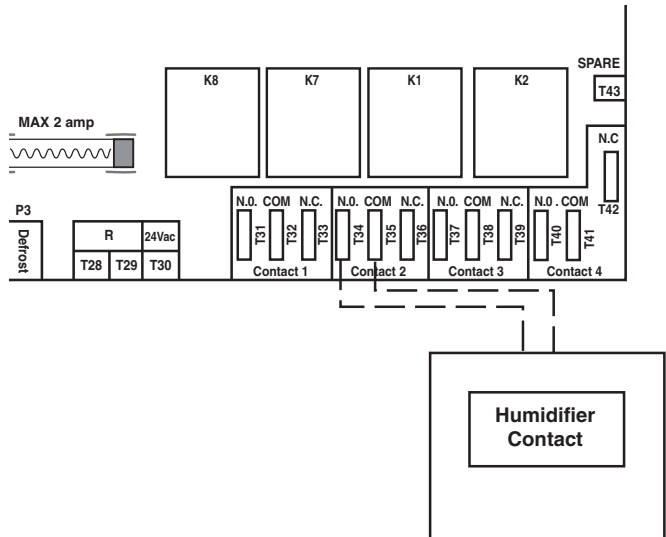

### Contact 2

This relay is a dry contact (no power supplied from board). The relay switches states when the CAF blower motor is in operation.

This relay can be used to interlock humidifiers, Air Cleaning Equipment, etc.

Power (if required) must be supplied to common from an external source.

Max. voltage - 120 volts

Max. Amperage - 10 amps



## Start-Up Procedure

In order for any appliance to work properly it must be set up and tested by a knowledgeable technician.

### The following conditions must be met prior to start-up:

1. Ensure that connecting water lines are purged and free of debris.  
Caution: solder or other debris may cause the furnace pump or check valve to malfunction.
2. Blower wheel rotates freely inside its housing.
3. Wiring connections are tight.
4. Water is sitting in the "P" trap below the HRV core.
5. All duct and pipe connections are sealed.
6. Check that styrene block is removed from under pump.
7. Front access door is on tight.
8. Fan speed selection:
  - a) **Heating/Cooling** - factory setting is at high speed and can be changed in the electrical box to medium-high or medium if required.
  - b) **Ventilation** - low speed is controlled by the Thermostat Fan switch.

### Once all of the necessary connections have been made, the Clean Air Furnace Start-Up Procedure is as follows:

1. Close shut-off valves separating the Clean Air Furnace from the water heater.
2. Set up water heater according to manufacturer's instructions.
3. Purge air from unit. To do so, open the supply shut-off valve to the furnace. Attach a garden hose to drain valve, and drain water until you get a continuous flow. Close the drain valve and purge the pump. To purge the air from the pump, turn the large screw on the face of the pump counter-clockwise until water leaks out, then tighten. Open the supply shut-off valve.
4. Turn on power supply to Clean Air Furnace.
5. Switch the room thermostat to heat. The thermostat should be set higher than the current room temperature in order to energize the pump and commence the heating cycle. (If the pump does not start, or the Clean Air Furnace is not producing heat, refer to the Troubleshooting Section in this manual.
6. Set room thermostat at desired temperature setting.

## Service/Maintenance

A dedicated maintenance program will prolong the life of the equipment, and maintain its optimum performance.

We recommend at least two (2) full inspections and cleanings per year under normal operating conditions, and more if circumstances warrant it (i.e. situations of heavy smoke may require servicing every one to two months).

### Service should include:

- Cleaning of screens protecting outside hoods.
- Cleaning of the HRV (aluminum) core.
- Inspect filters and replace as necessary.
- Wipe down drain pans and inside of cabinet, using a mild disinfectant.
- Ensure condensate drain has free flow of moisture.
- Inspect operation of blowers and electrical panel.
- Confirm operation.

### Clean Core Twice a Year

- a) Open access door.
- b) Carefully grip ends of core, and pull evenly outward. Core may be snug, but will slide out of the "H" channel.
- c) Once removed from the cabinet, remove the foam filters.
- d) Wash the core in warm soapy water (do not use dishwasher).
- e) Install the clean filters
- f) Install the clean core.

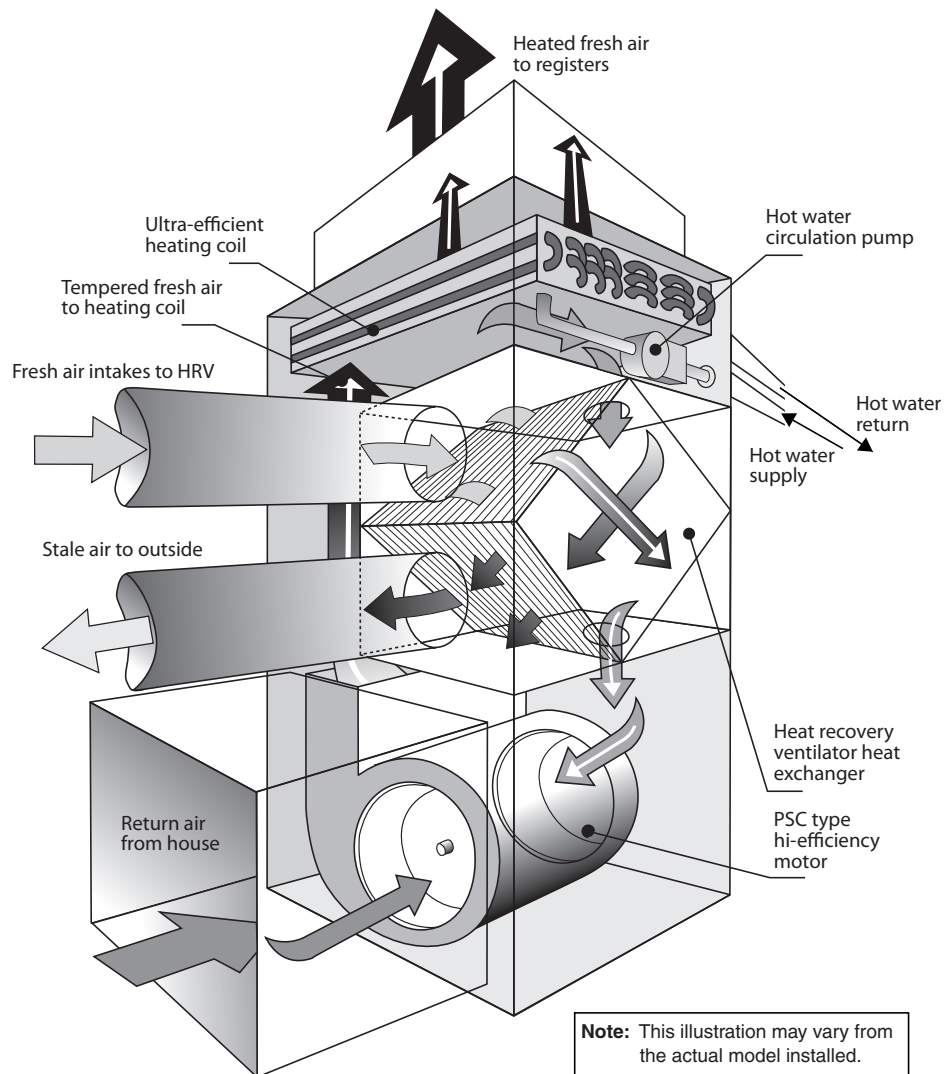

## Troubleshooting

### Lack of heat

1. Check that the room thermostat is set to the desired temperature.
2. Confirm the units have power and the shut-off valves are open.
3. Ensure there is power to the unit and that the pump is working. If the pump is not working properly it may be stuck. Disconnect power and remove screw in center face of the pump. Using a screwdriver, turn the pump shaft several times to free it from sticking. Replace center-screw and re-connect power. If pump still fails to start, it may require replacement.
4. Confirm that the hot water heater is working and that hot water is entering the Clean Air Furnace.
5. Verify that the airflow in and out of the system matches designed specs. If airflow is low, check for blockage in the filter or some other obstruction.
6. Make sure your water heater is sized large enough for heat load of house and for domestic hot water use.
7. Air may still be in the water lines. If so, re-purge the system according to the start up procedure.
8. Confirm that the inlet and outlet pipe connections are not reversed.
9. Ensure that there are no other restrictions in the water lines, such as faulty valves, or debris.

### Pump is noisy

Pumps can become noisy when air remaining in the lines interfere with their operation. If this occurs re-purge the system as indicated in the Start-Up Procedure.

### HRV core freezes up

1. Make sure that the supply and exhaust lines are balanced according to the "Balancing Procedure" in this manual.
2. If out of balance, ensure that the balancing dampers have not been moved and that there are no obstructions in the outside hoods.

### During cooling cycle, hot water circulates through the coil

If the check valve inside the cabinet is stuck in the open position, hot water may infiltrate the heating coil. This occurs when the hot pipes are not capped-off during installation or service and foreign debris enters the piping. This debris can settle under the check valve seat and permit hot water to flow into the coil. The problem can be corrected by repeatedly flushing the heating loop until it is clean.

### Water sits in drain pipes

1. Check drain pans or lines for plugs.
2. Confirm that the HRV core is installed according to manufactures recommendations.
3. Check the drain line for kinks.
4. Make sure that the O-ring in the drain nozzles sit flat.
5. Ensure the drain line has enough "fall" to it.

### Condensation/ice forming inside ventilation ducts

A rip in the vapor barrier or poorly sealed joints may cause condensation or ice to form on the ducting. If this occurs, replace the entire line.

## How the Dehumidistat Works

High indoor humidity levels are apparent from the visible condensation on windows. The amount of condensation on the windows will increase as outdoor temperatures drop.

Your CAF will reduce indoor humidity levels when outdoor air is drier than indoor air. This usually occurs during the heating season when outdoor temperatures are less than 15°C (59°F).

The Optional Dehumidistat (99-DH01) can be set to achieve a further dehumidification effect from your CAF. High speed ventilation will be initiated upon exceeding the dehumidistat set point. Once the humidity in the house is reduced, the CAF will revert back to its normal operation.

We suggest operating the unit for the first few days without use of the dehumidistat function to observe if a further dehumidification effect will be required. The dehumidistat operates in % of RH (relative humidity) with 80 being high and 20 being low. Set the Dehumidistat to 80% to disable. If, after a few days, further dehumidification is required (the house is still too humid), set the humidity level to a lower amount.

The average person is comfortable between 30-50% RH. The dehumidistat should be set to OFF for all seasons except the heating season. OFF is achieved by selecting - no light for dehumidistat.

**Example Model Number**

**CAF - U - S2A - 24 - P16**

**Model Configuration**

**CAF** - Clean Air Furnace (Built-in HRV)  
Refer to AH (Air Handler) specifications if a built-in HRV is *not* required.

**Configuration**

**U** - Upflow - Return Air off Left or Right side  
**D** - Downflow - Return Air off Left side, Right side or Top  
(not available for L2A or 00 Coils)

**Hydronic Coil Size**

**S4A** - Small Coil - 4 Row Coil  
**L2A** - Large Coil - 2 Row Coil (*available in upflow only*)  
**L4A** - Large Coil - 4 Row Coil  
**00** - No Hydronics - No Heating Coil, No Pump  
(*available in upflow only*)

**Available Clean Air Furnace Models**

- CAF-U-S4A-24-P16(E16)
- CAF-D-S4A-24-P16(E16)
- CAF-U-L4A-36-P16(E16)
- CAF-D-L4A-36-P16(E16)
- CAF-U-L2A-48-P16(E16)
- CAF-U-00-24-P16(E16)
- CAF-U-00-36-P16(E16)
- CAF-U-00-48-P16(E16)

**\* CFM (High Speed) Cooling Capacity**

- 24** - 2 tons
- 30** - 2.5 tons
- 36** - 3.0 tons
- 48** - 4.0 tons

\*Cooling coils not available from Airia

**! ATTENTION**

Refer to individual specification pages for Hydronic Coil and Blower outputs and configurations.

**Motor Configuration**

**P16** - Standard PSC Motor 120V/60Hz  
**E16** - Upgrade ECM Motor 120V/60Hz

**Core** Ventilation system has patented aluminum heat recovery core (standard) or an enthalpic energy recovery core (optional) for energy-efficient ventilation. Enthalpic cores are recommended for regions where the temperature does not drop below 25°F (-4°C).

**Filters** Washable air filters in exhaust and supply air streams of ventilation section, 1" (25 mm) pleated in return plenum side.

**Case** Pre-painted galvanized steel for superior corrosion resistance.

### S4A-24 Coil Output Chart (1000's of BTUH)

CFM @ .5" WG	3 GPM												4 GPM						5 GPM					
	130	140	150	160	170	180	130	140	150	160	170	180	130	140	150	160	170	180						
890	40.7	47.7	54.8	61.9	69.0	76.2	43.8	51.3	58.9	66.5	74.1	81.7	45.7	53.6	61.4	69.3	77.2	85.1						
790	38.0	44.5	51.0	57.6	64.3	70.9	40.5	47.4	54.4	61.3	68.3	75.4	42.0	49.2	56.4	63.6	70.8	78.0						
740	36.5	42.7	49.0	55.3	61.7	68.0	38.7	45.3	51.9	58.6	65.3	72.0	40.0	46.8	53.7	60.5	67.4	74.3						
660	33.8	39.6	45.5	51.3	57.2	63.0	35.6	41.7	47.8	53.9	60.0	66.2	36.7	42.9	49.2	55.4	61.7	68.0						
CFM @ .25" WG	3 GPM												4 GPM						5 GPM					
1030	44.0	51.7	59.3	67.0	74.8	82.5	48.0	56.2	64.5	72.8	81.2	89.6	50.5	59.1	67.8	76.5	85.3	94.1						
900	41.0	48.0	55.1	62.3	69.4	76.6	44.1	51.7	59.3	66.9	74.6	82.3	46.1	54.0	61.9	69.8	77.8	85.8						
825	38.9	46.7	52.4	59.2	66.0	72.8	41.7	48.8	56.0	63.2	70.4	77.6	43.5	50.9	58.3	65.8	73.3	80.8						
740	36.5	42.7	49.0	55.3	61.7	68.0	38.7	45.5	51.9	58.6	65.3	72.0	40.0	46.9	53.7	60.5	67.4	74.3						
Water Temp.	130	140	150	160	170	180	130	140	150	160	170	180	130	140	150	160	170	180						

### Dimensions & Clearances

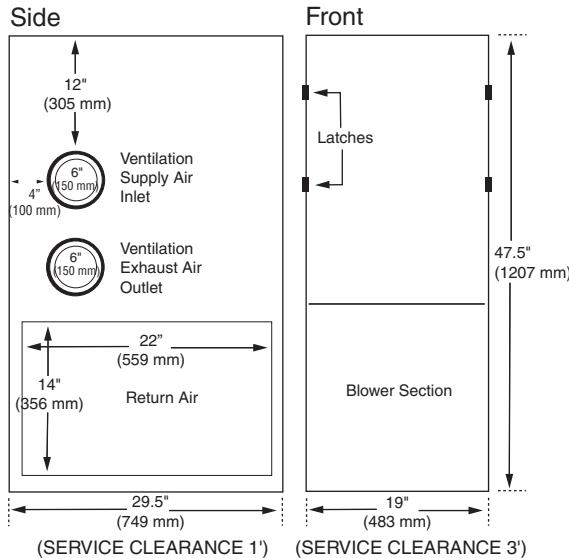
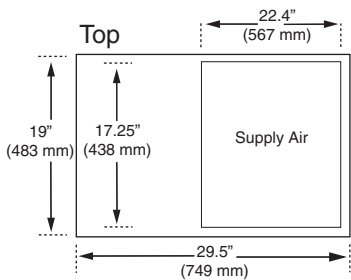

Model	CAF-U-S4A-24-P16
Voltage	120 VAC 60 Hz
Hp	1/3
Amps (total)	8
Water Connections	1/2" (12 mm) Copper Soldered Connection
Airflow (High) .25 in wg .5 in. wg	1030 CFM 890 CFM
Ventilation Airflow	100 - 140 CFM
Effectiveness (Aluminum Core)	70%
Net Weight	150 lbs.
Shipping Weight	165 lbs.

Note: Ventilation ports and return plenum opening available off either side of cabinet. All units conform to CSA and UL Standards.

### Options

**99-186** Weatherhoods, Two - 6" (150 mm) c/w 1/4" (6 mm) mesh screen

**99-RSK6** 6" (150 mm) back draft damper

**99-DH01 Lifestyle Dehumidistat** - Initiates high speed ventilation for 20, 40, or 60 minutes (3 wire) 20 gauge wire (minimum) 100 ft. length

### Warranty

Units carry a lifetime warranty on the heat recovery (aluminum) core, a five year warranty on the energy recovery (enthalpic) core and a five year replacement parts warranty on all other components.

Date: \_\_\_\_\_

Tag: \_\_\_\_\_ Qty: \_\_\_\_\_

Project: \_\_\_\_\_

Engineer: \_\_\_\_\_

### OPTIONAL TIMER

**99-DET01 Lifestyle 20/40/60 Minute Timer** - Initiates high speed ventilation for 20, 40, 60 minutes. (3 wire) 20 gauge wire (minimum) 100 ft. length

Contractor: \_\_\_\_\_

Supplier: \_\_\_\_\_

Quote#: \_\_\_\_\_

Submitted by: \_\_\_\_\_

- Core** Ventilation system has patented aluminum heat recovery core (standard) or an enthalpic energy recovery core (optional) for energy-efficient ventilation. Enthalpic cores are recommended for regions where the temperature does not drop below 25°F (-4°C).
- Filters** Washable air filters in exhaust and supply air streams of ventilation section, 1" (25 mm) pleated in return plenum side
- Case** Pre-painted galvanized steel for superior corrosion resistance.

**S4A-24 Coil Output Chart (1000's of BTUH)**

CFM @ 5" WG	S4A-24 Coil Output Chart (1000's of BTUH)																		
	40.7	47.7	54.8	61.9	69.0	76.2	83.8	91.3	98.9	106.5	114.1	121.7	129.3	136.9	144.5	152.1	159.7	167.3	
890	40.7	47.7	54.8	61.9	69.0	76.2	83.8	91.3	98.9	106.5	114.1	121.7	129.3	136.9	144.5	152.1	159.7	167.3	
790	38.0	44.5	51.0	57.6	64.3	70.9	77.5	84.1	90.7	97.3	103.9	110.5	117.1	123.7	130.3	136.9	143.5	150.1	
740	36.5	42.7	49.0	55.3	61.7	68.0	74.3	80.7	87.0	93.4	99.7	106.1	112.5	118.9	125.3	131.7	138.1	144.5	
660	33.8	39.6	45.5	51.3	57.2	63.0	68.8	74.7	80.5	86.4	92.2	98.1	104.0	109.9	115.8	121.7	127.6	133.5	
CFM @ 25" WG	S4A-24 Coil Output Chart (1000's of BTUH)																		
	44.0	51.7	59.3	67.0	74.8	82.5	90.2	97.9	105.6	113.3	121.0	128.7	136.4	144.1	151.8	159.5	167.2	174.9	
	1030	44.0	51.7	59.3	67.0	74.8	82.5	90.2	97.9	105.6	113.3	121.0	128.7	136.4	144.1	151.8	159.5	167.2	174.9
	900	41.0	48.0	55.1	62.3	69.4	76.6	83.7	90.8	97.9	105.0	112.1	119.2	126.3	133.4	140.5	147.6	154.7	161.8
825	38.9	46.7	52.4	59.2	66.0	72.8	79.6	86.4	93.2	100.0	106.8	113.6	120.4	127.2	134.0	140.8	147.6	154.4	
740	36.5	42.7	49.0	55.3	61.7	68.0	74.3	80.7	87.0	93.4	99.7	106.1	112.5	118.9	125.3	131.7	138.1	144.5	
Water Temp.	130	140	150	160	170	180	130	140	150	160	170	180	130	140	150	160	170	180	

### Dimensions & Clearances

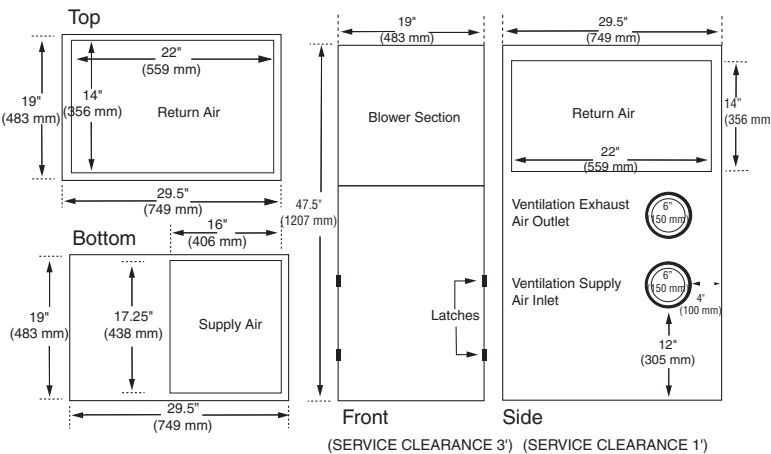

Model	CAF-D-S4A-24-P16
Voltage	120 VAC 60 Hz
Hp	1/3
Amps (total)	8
Water Connections	1/2" (12 mm) Copper Soldered Connection
Airflow (High) .25 in. wg .5 in. wg	1030 CFM 890 CFM
Ventilation Airflow	100 - 140 CFM
Effectiveness (Aluminum Core)	70%
Net Weight	150 lbs.
Shipping Weight	165 lbs.

Note: Ventilation ports and return plenum opening available off either side of cabinet.  
All units conform to CSA and UL Standards.

### Options

- 99-186** Weatherhoods, Two - 6" (150 mm) c/w 1/4" (6 mm) mesh screen
- 99-RSK6** 6" (150 mm) back draft damper
- 99-DH01 Lifestyle Dehumidistat** - Initiates high speed ventilation for 20, 40, or 60 minutes (3 wire) 20 gauge wire (minimum) 100 ft. length

### OPTIONAL TIMER

**99-DET01 Lifestyle 20/40/60 Minute Timer** - Initiates high speed ventilation for 20, 40, 60 minutes. (3 wire) 20 gauge wire (minimum) 100 ft. length

### Warranty

Units carry a lifetime warranty on the heat recovery (aluminum) core, a five year warranty on the energy recovery (enthalpic) core and a five year replacement parts warranty on all other components.

Date: \_\_\_\_\_  
 Tag: \_\_\_\_\_ Qty: \_\_\_\_\_  
 Project: \_\_\_\_\_  
 Engineer: \_\_\_\_\_

Contractor: \_\_\_\_\_  
 Supplier: \_\_\_\_\_  
 Quote#: \_\_\_\_\_  
 Submitted by: \_\_\_\_\_

- Core** Ventilation system has patented aluminum heat recovery core (standard) or an enthalpic energy recovery core (optional) for energy-efficient ventilation. Enthalpic cores are recommended for regions where the temperature does not drop below 25°F (-4°C).
- Filters** Washable air filters in exhaust and supply air streams of ventilation section, 1" (25 mm) pleated in return plenum side
- Case** Pre-painted galvanized steel for superior corrosion resistance.

**L4A-36 Coil Output Chart (1000's of BTUH)**

CFM @ .25" WG CFM @ .5" WG	<b>1180</b>	51.4	60.2	69.0	77.9	86.8	95.8	56.3	65.9	75.6	85.3	95.0	104.8	59.4	69.5	79.7	89.9	100.1	110.3
	<b>1120</b>	50.0	58.7	67.2	75.9	84.5	93.2	54.5	63.9	73.2	82.6	92.0	101.5	57.4	67.1	76.9	86.8	96.6	106.5
	<b>890</b>	43.9	51.4	60.0	66.5	74.1	81.7	46.9	54.9	62.9	70.9	79.0	87.1	48.7	56.9	65.3	73.5	81.8	90.2
	<b>675</b>	36.6	42.8	49.0	55.3	61.5	67.8	38.2	44.7	51.2	57.7	64.2	70.7	37.3	43.7	50.0	56.4	62.8	69.2
	<b>1350</b>	54.7	64.2	73.6	83.1	92.6	102.1	60.8	71.2	81.7	92.2	102.7	113.3	64.7	75.8	86.8	98.0	109.2	120.4
	<b>1275</b>	53.3	62.5	71.7	80.9	90.2	99.5	58.9	69.0	79.1	89.3	99.5	109.7	62.4	73.1	83.8	94.5	105.3	116.5
	<b>940</b>	45.4	53.2	60.9	68.8	76.6	84.5	48.7	57.0	65.3	73.7	82.1	90.4	50.7	59.3	67.9	76.6	85.3	94.0
	<b>730</b>	38.6	45.2	51.8	58.4	65.0	71.7	40.6	47.5	54.4	61.3	68.3	75.2	41.8	48.8	55.9	63.0	70.1	77.2
	<b>Water Temp.</b>	<b>130</b>	<b>140</b>	<b>150</b>	<b>160</b>	<b>170</b>	<b>180</b>	<b>130</b>	<b>140</b>	<b>150</b>	<b>160</b>	<b>170</b>	<b>180</b>	<b>130</b>	<b>140</b>	<b>150</b>	<b>160</b>	<b>170</b>	<b>180</b>

3 GPM

4 GPM

5 GPM

### Dimensions & Clearances

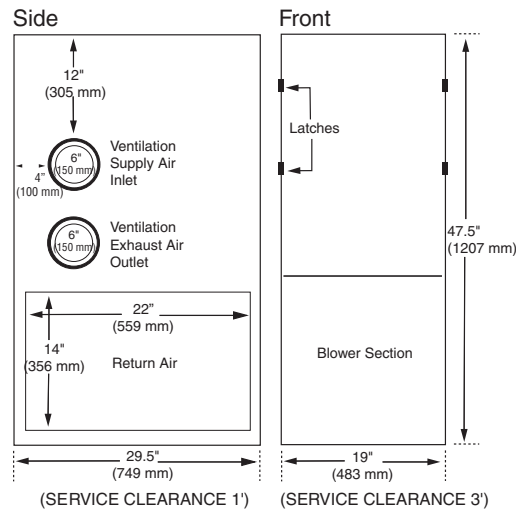
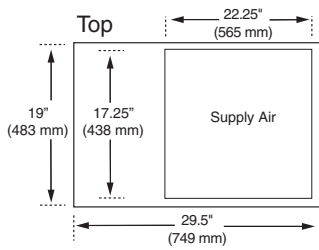

Note: Ventilation ports and return plenum opening available off either side of cabinet. All units conform to CSA and UL Standards.

Model	CAF-U-L4A-36-P16
Voltage	120 VAC 60 Hz
Hp	1/2
Amps (total)	10.6
Water Connections	3/4" (19 mm) Copper Soldered Connection
Airflow (High)	.25 in wg 1180 CFM
Ventilation Airflow	100 - 140 CFM
Effectiveness (Aluminum Core)	70%
Net Weight	150 lbs.
Shipping Weight	165 lbs.

### Options

- 99-186** Weatherhoods, Two - 6" (150 mm) c/w 1/4" (6 mm) mesh screen
- 99-RSK6** 6" (150 mm) back draft damper
- 99-DH01 Lifestyle Dehumidistat** - Initiates high speed ventilation for 20, 40, or 60 minutes (3 wire) 20 gauge wire (minimum) 100 ft. length

### OPTIONAL TIMER

**99-DET01 Lifestyle 20/40/60 Minute Timer** - Initiates high speed ventilation for 20, 40, 60 minutes. (3 wire) 20 gauge wire (minimum) 100 ft. length

### Warranty

Units carry a lifetime warranty on the heat recovery (aluminum) core, a five year warranty on the energy recovery (enthalpic) core and a five year replacement parts warranty on all other components.

Date: \_\_\_\_\_  
 Tag: \_\_\_\_\_ Qty: \_\_\_\_\_  
 Project: \_\_\_\_\_  
 Engineer: \_\_\_\_\_

Contractor: \_\_\_\_\_  
 Supplier: \_\_\_\_\_  
 Quote#: \_\_\_\_\_  
 Submitted by: \_\_\_\_\_



511 McCormick Blvd.  
 London, Ontario N5W 4C8  
 T 1-855-247-4200  
 F 1-800-494-4185  
 Email: info@lifebreath.com

270 Regency Ridge, Suite 210  
 Dayton, Ohio 45459  
 T (937) 439-6676  
 F (937) 439-6685  
 Website: www.lifebreath.com





- Core** Ventilation system has patented aluminum heat recovery core (standard) or an enthalpic energy recovery core (optional) for energy-efficient ventilation. Enthalpic cores are recommended for regions where the temperature does not drop below 25°F (-4°C).
- Filters** Washable air filters in exhaust and supply air streams of ventilation section, 1" (25 mm) pleated in return plenum side
- Case** Pre-painted galvanized steel for superior corrosion resistance.

### L4A-36 Coil Output Chart (1000's of BTUH)

CFM @ .25" WG	CFM @ .5" WG																		
	1180	1120	890	675	1350	1275	940	730	130	140	150	160	170	180	130	140	150	160	170
	51.4	60.2	69.0	77.9	86.8	95.8	56.3	65.9	75.6	85.3	95.0	104.8	59.4	69.5	79.7	89.9	100.1	110.3	
	50.0	58.7	67.2	75.9	84.5	93.2	54.5	63.9	73.2	82.6	92.0	101.5	57.4	67.1	76.9	86.8	96.6	106.5	
	43.9	51.4	60.0	66.5	74.1	81.7	46.9	54.9	62.9	70.9	79.0	87.1	48.7	56.9	65.3	73.5	81.8	90.2	
	36.6	42.8	49.0	55.3	61.5	67.8	38.2	44.7	51.2	57.7	64.2	70.7	37.3	43.7	50.0	56.4	62.8	69.2	
	54.7	64.2	73.6	83.1	92.6	102.1	60.8	71.2	81.7	92.2	102.7	113.3	64.7	75.8	86.8	98.0	109.2	120.4	
	53.3	62.5	71.7	80.9	90.2	99.5	58.9	69.0	79.1	89.3	99.5	109.7	62.4	73.1	83.8	94.5	105.3	116.5	
	45.4	53.2	60.9	68.8	76.6	84.5	48.7	57.0	65.3	73.7	82.1	90.4	50.7	59.3	67.9	76.6	85.3	94.0	
	38.6	45.2	51.8	58.4	65.0	71.7	40.6	47.5	54.4	61.3	68.3	75.2	41.8	48.8	55.9	63.0	70.1	77.2	
Water Temp.	130	140	150	160	170	180	130	140	150	160	170	180	130	140	150	160	170	180	

3 GPM

4 GPM

5 GPM

### Dimensions & Clearances

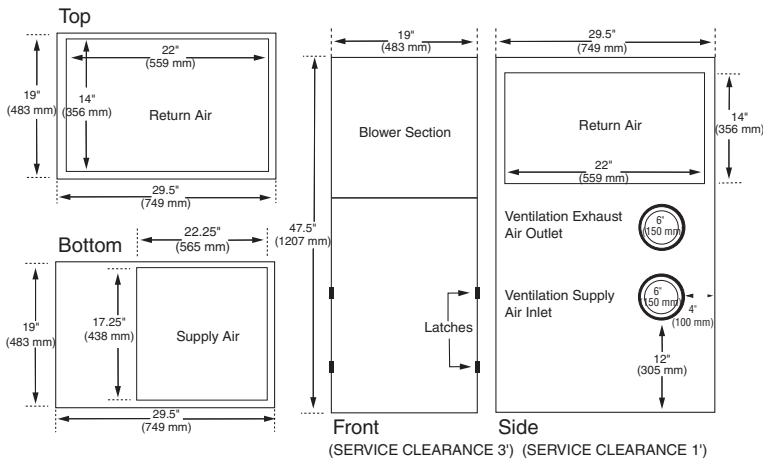

Model	CAF-D-L4A-36-P16
Voltage	120 VAC 60 Hz
Hp	1/2
Amps (total)	10.6
Water Connections	3/4" (19 mm) Copper Soldered Connection
Airflow (High)	.25 in wg .5 in. wg
Water Connections	3/4" (19 mm) Copper Soldered Connection
Airflow (High)	.25 in wg .5 in. wg
Ventilation Airflow	100 - 140 CFM
Effectiveness (Aluminum Core)	70%
Net Weight	150 lbs.
Shipping Weight	165 lbs.

Note: Ventilation ports and return plenum opening available off either side of cabinet.  
All units conform to CSA and UL Standards.

### Options

- 99-186** Weatherhoods, Two - 6" (150 mm) c/w 1/4" (6 mm) mesh screen
- 99-RSK6** 6" (150 mm) back draft damper
- 99-DH01 Lifestyle Dehumidistat** - Initiates high speed ventilation for 20, 40, or 60 minutes (3 wire) 20 gauge wire (minimum) 100 ft. length

### OPTIONAL TIMER

**99-DET01 Lifestyle 20/40/60 Minute Timer** - Initiates high speed ventilation for 20, 40, 60 minutes. (3 wire) 20 gauge wire (minimum) 100 ft. length

### Warranty

Units carry a lifetime warranty on the heat recovery (aluminum) core, a five year warranty on the energy recovery (enthalpic) core and a five year replacement parts warranty on all other components.

Date: \_\_\_\_\_  
 Tag: \_\_\_\_\_ Qty: \_\_\_\_\_  
 Project: \_\_\_\_\_  
 Engineer: \_\_\_\_\_

Contractor: \_\_\_\_\_  
 Supplier: \_\_\_\_\_  
 Quote#: \_\_\_\_\_  
 Submitted by: \_\_\_\_\_



511 McCormick Blvd.  
 London, Ontario N5W 4C8  
 T 1-855-247-4200  
 F 1-800-494-4185  
 Email: info@lifebreath.com

270 Regency Ridge, Suite 210  
 Dayton, Ohio 45459  
 T (937) 439-6676  
 F (937) 439-6685  
 Website: www.lifebreath.com



- Core** Ventilation system has patented aluminum heat recovery core (standard) or an enthalpic energy recovery core (optional) for energy-efficient ventilation. Enthalpic cores are recommended for regions where the temperature does not drop below 25°F (-4°C).
- Filters** Washable air filters in exhaust and supply air streams of ventilation section, 1" (25 mm) pleated in return plenum side.
- Case** Pre-painted galvanized steel for superior corrosion resistance.

**L2A-48 Coil Output Chart (1000's of BTUH)**

CFM@ .25" WG	1589	32.9	38.5	44.2	49.8	55.4	61.1	35.2	41.2	47.2	53.2	59.2	65.3	36.7	43.0	49.2	55.4	61.7	68.0
	1469	32.8	37.8	43.3	48.9	54.4	60.0	34.5	40.4	46.2	52.1	58.0	63.9	36.0	42.0	48.1	54.3	60.4	66.5
	1033	30.2	35.3	40.4	45.6	50.8	55.9	32.0	37.5	42.9	48.4	53.8	59.3	33.3	38.9	44.5	50.2	55.8	61.5
	690	24.7	28.9	33.1	37.3	41.5	45.7	25.9	30.2	34.6	39.0	43.4	47.8	26.6	31.1	35.6	40.1	44.6	49.1
	1888	35.1	41.0	47.0	53.1	59.1	65.1	37.7	44.1	50.6	57.0	63.5	70.0	39.5	46.2	52.9	59.7	66.4	73.2
	1650	34.6	40.4	46.4	52.3	58.2	64.2	37.1	43.4	49.8	56.1	62.5	68.9	38.8	45.4	52.0	58.7	65.3	71.9
	1134	31.2	36.5	41.8	47.1	52.4	57.8	33.2	38.8	44.4	50.1	55.8	61.4	34.5	40.3	46.2	52.0	57.9	63.8
	806	25.2	29.5	33.8	38.1	42.4	46.7	26.4	30.9	35.4	39.9	44.4	48.9	27.2	31.8	36.4	41.0	45.6	50.2
	Water Temp.	130	140	150	160	170	180	130	140	150	160	170	180	130	140	150	160	170	180
		3 GPM						4 GPM						5 GPM					

### Dimensions & Clearances

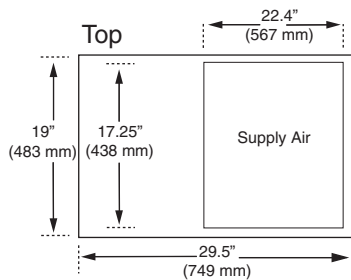

Note: Ventilation ports and return plenum opening available off either side of cabinet. All units conform to CSA and UL Standards.

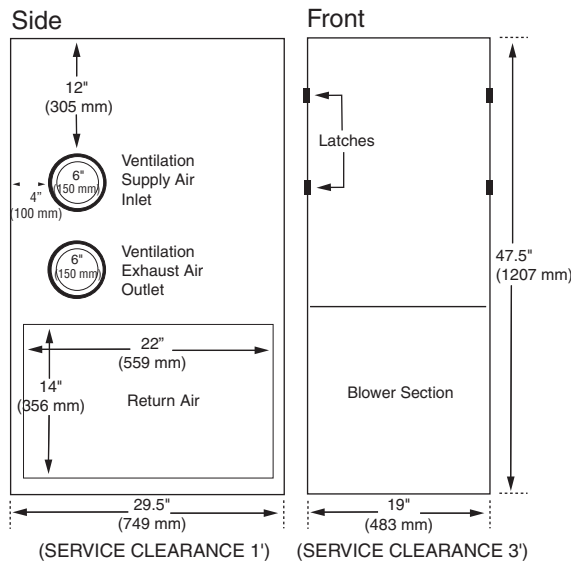

Model	CAF-U-L2A-48-P16
Voltage	120 VAC 60 Hz
Hp	1/2
Amps (total)	10.6
Water Connections	1/2" (12 mm) Copper Soldered Connection
Airflow (High)	.25 in wg: 1588 CFM .5 in wg: 1388 CFM
Ventilation Airflow	100 - 140 CFM
Effectiveness (Aluminum Core)	70%
Net Weight	150 lbs.
Shipping Weight	165 lbs.

### Options

**99-186** Weatherhoods, Two - 6" (150 mm) c/w 1/4" (6 mm) mesh screen

**99-RSK6** 6" (150 mm) back draft damper

**99-DH01 Lifestyle Dehumidistat** - Initiates high speed ventilation for 20, 40, or 60 minutes (3 wire) 20 gauge wire (minimum) 100 ft. length

### Warranty

Units carry a lifetime warranty on the heat recovery (aluminum) core, a five year warranty on the energy recovery (enthalpic) core and a five year replacement parts warranty on all other components.

Date: \_\_\_\_\_

Tag: \_\_\_\_\_ Qty: \_\_\_\_\_

Project: \_\_\_\_\_

Engineer: \_\_\_\_\_

### OPTIONAL TIMER

**99-DET01 Lifestyle 20/40/60 Minute Timer** - Initiates high speed ventilation for 20, 40, 60 minutes. (3 wire) 20 gauge wire (minimum) 100 ft. length

Contractor: \_\_\_\_\_

Supplier: \_\_\_\_\_

Quote#: \_\_\_\_\_

Submitted by: \_\_\_\_\_

- Core** Ventilation system has patented aluminum heat recovery core (standard) or an enthalpic energy recovery core (optional) for energy-efficient ventilation. Enthalpic cores are recommended for regions where the temperature does not drop below 25°F (-4°C).
- Filters** Washable air filters in exhaust and supply air streams of ventilation section, 1" (25 mm) pleated in return plenum side.
- Case** Pre-painted galvanized steel for superior corrosion resistance.

Static Pressure	Fan Speed (cfm)			
	Low	M Low	M High	High
0.5 " WC	660	740	790	890
0.25 " WC	740	825	900	1030

### Dimensions & Clearances

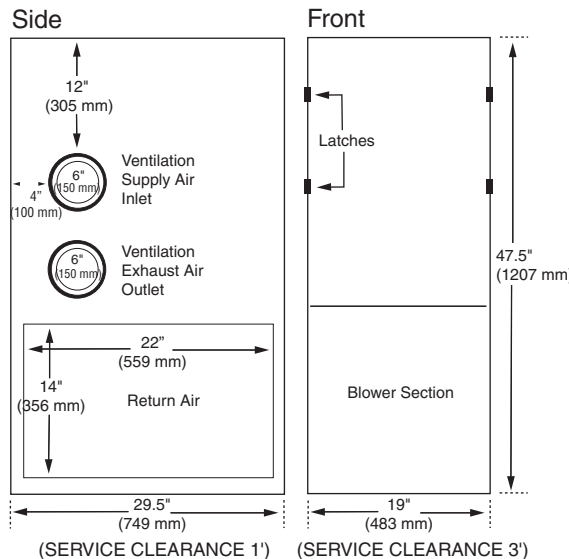
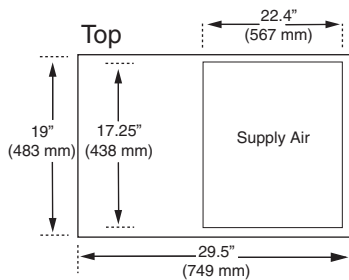

Model	CAF-U-00-24-P16
Voltage	120 VAC 60 Hz
Hp	1/3
Amps (total)	8
Water Connections	1/2" (12 mm) Copper Soldered Connection
Airflow (High)	1030 CFM
.25 in wg	890 CFM
.5 in. wg	
Ventilation Airflow	100 - 140 CFM
Effectiveness (Aluminum Core)	70%
Net Weight	150 lbs.
Shipping Weight	165 lbs.

Note: Ventilation ports and return plenum opening available off either side of cabinet. All units conform to CSA and UL Standards.

### Options

- 99-186** Weatherhoods, Two - 6" (150 mm) c/w 1/4" (6 mm) mesh screen
- 99-RSK6** 6" (150 mm) back draft damper
- 99-DH01 Lifestyle Dehumidistat** - Initiates high speed ventilation for 20, 40, or 60 minutes (3 wire) 20 gauge wire (minimum) 100 ft. length

### OPTIONAL TIMER

**99-DET01 Lifestyle 20/40/60 Minute Timer** - Initiates high speed ventilation for 20, 40, 60 minutes. (3 wire) 20 gauge wire (minimum) 100 ft. length

### Warranty

Units carry a lifetime warranty on the heat recovery (aluminum) core, a five year warranty on the energy recovery (enthalpic) core and a five year replacement parts warranty on all other components.

Date: \_\_\_\_\_  
 Tag: \_\_\_\_\_ Qty: \_\_\_\_\_  
 Project: \_\_\_\_\_  
 Engineer: \_\_\_\_\_

Contractor: \_\_\_\_\_  
 Supplier: \_\_\_\_\_  
 Quote#: \_\_\_\_\_  
 Submitted by: \_\_\_\_\_

- Core** Ventilation system has patented aluminum heat recovery core (standard) or an enthalpic energy recovery core (optional) for energy-efficient ventilation. Enthalpic cores are recommended for regions where the temperature does not drop below 25°F (-4°C).
- Filters** Washable air filters in exhaust and supply air streams of ventilation section, 1" (25 mm) pleated in return plenum side.
- Case** Pre-painted galvanized steel for superior corrosion resistance.

Static Pressure	Fan Speed (cfm)			
	Low	M Low	M High	High
0.5 " WC	675	890	1120	1180
0.25 " WC	730	940	1275	1350

### Dimensions & Clearances

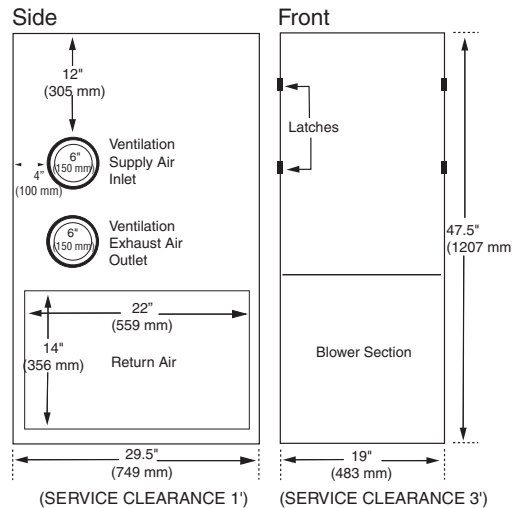
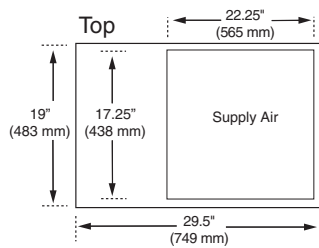

Model	CAF-U-00-36-P16
Voltage	120 VAC 60 Hz
Hp	1/2
Amps (total)	10.6
* Airflow (High)	
.25 in wg	1350 CFM
.5 in. wg	1180 CFM
Ventilation Airflow	100 - 140 CFM
Effectiveness (Aluminum Core)	70%
Net Weight	115 lbs.
Shipping Weight	130 lbs.

Note: Ventilation ports and return plenum opening available off either side of cabinet. All units conform to CSA and UL Standards.

\* Airflow performance assumes an evaporator coil static pressure loss of .25" WC

### OPTIONS

**99-186** Weatherhoods, Two - 6" (150 mm) c/w 1/4" (6 mm) mesh screen

**99-RSK6** 6" (150 mm) back draft damper

**99-DH01 Lifestyle Dehumidistat** - Initiates high speed ventilation for 20, 40, or 60 minutes (3 wire) 20 gauge wire (minimum) 100 ft. length

### Warranty

Units carry a lifetime warranty on the heat recovery (aluminum) core, a five year warranty on the energy recovery (enthalpic) core and a five year replacement parts warranty on all other components.

### OPTIONAL TIMERS

**99-DET01 Lifestyle 20/40/60 Minute Timer** - Initiates high speed ventilation for 20, 40, 60 minutes. (3 wire) 20 gauge wire (minimum) 100 ft. length

Date: \_\_\_\_\_  
 Tag: \_\_\_\_\_ Qty: \_\_\_\_\_  
 Project: \_\_\_\_\_  
 Engineer: \_\_\_\_\_

Contractor: \_\_\_\_\_  
 Supplier: \_\_\_\_\_  
 Quote#: \_\_\_\_\_  
 Submitted by: \_\_\_\_\_

- Core** Ventilation system has patented aluminum heat recovery core (standard) or an enthalpic energy recovery core (optional) for energy-efficient ventilation. Enthalpic cores are recommended for regions where the temperature does not drop below 25°F (-4°C).
- Filters** Washable air filters in exhaust and supply air streams of ventilation section, 1" (25 mm) pleated in return plenum side.
- Case** Pre-painted galvanized steel for superior corrosion resistance.

Static Pressure	Fan Speed (cfm)			
	Low	M Low	M High	High
0.5 " WC	690	1033	1469	1589
0.25 " WC	806	1134	1650	1888

### Dimensions & Clearances

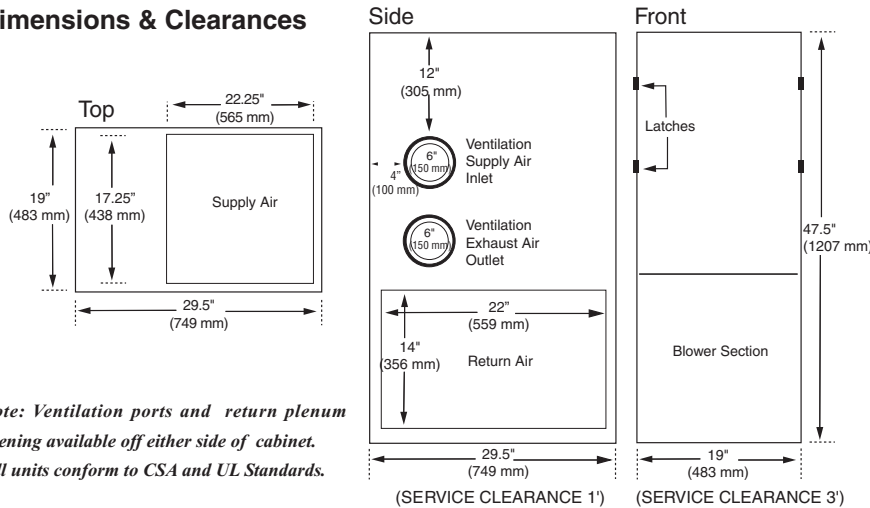

*Note: Ventilation ports and return plenum opening available off either side of cabinet.  
All units conform to CSA and UL Standards.*

Model	CAF-U-00-48-P16
Voltage	120 VAC 60 Hz
Hp	1/2
Amps (total)	10.6
* Airflow (High) .25 in wg .5 in. wg	1888 CFM 1589 CFM
Ventilation Airflow	100 - 140 CFM
Effectiveness (Aluminum Core)	70%
Net Weight	132 lbs.
Shipping Weight	147 lbs.

*\* Airflow performance assumes an evaporator coil static pressure loss of .25" WC.*

### OPTIONAL

**99-186** Weatherhoods, Two - 6" (150 mm) c/w 1/4" (6 mm) mesh screen

**99-RSK6** 6" (150 mm) back draft damper

**99-DH01 Lifestyle Dehumidistat** - Initiates high speed ventilation for 20, 40, or 60 minutes (3 wire) 20 gauge wire (minimum) 100 ft. length

### Warranty

Units carry a lifetime warranty on the heat recovery (aluminum) core, a five year warranty on the energy recovery (enthalpic) core and a five year replacement parts warranty on all other components.

Date: \_\_\_\_\_  
 Tag: \_\_\_\_\_ Qty: \_\_\_\_\_  
 Project: \_\_\_\_\_  
 Engineer: \_\_\_\_\_

### OPTIONAL TIMER

**99-DET01 Lifestyle 20/40/60 Minute Timer** - Initiates high speed ventilation for 20, 40, 60 minutes. (3 wire) 20 gauge wire (minimum) 100 ft. length

Contractor: \_\_\_\_\_  
 Supplier: \_\_\_\_\_  
 Quote#: \_\_\_\_\_  
 Submitted by: \_\_\_\_\_

## System Commissioning

This section of the manual is designed to be used with the “Commissioning of Integrated Combo System” worksheet. The worksheet is designed to guide you through the start-up process in a logical, step by step method which should minimize the work and time involved in having the system meet the designed parameters.

The following conditions are assumed:

- The air filter is in place
- All supply diffusers and return grilles are fully open and unrestricted
- Hot water is available to the furnace
- The drain valve for the heating loop is closed
- The shut off valves for the heating loop are fully open
- The throttling valve for the heating loop (if applicable), is fully opened
- Electrical power is available at the furnace
- The return air temperature from the house is approximately 70°F (21°C)

# COMMISSIONING OF INTEGRATED COMBO SYSTEM



*Training Courses and Forms  
are available from  
HRAI Skill Tech Academy  
1-800-267-2231*

**Designer/Signature:** \_\_\_\_\_

Phone ( ) \_\_\_\_\_ Fax ( ) \_\_\_\_\_ Date: D \_\_\_\_\_ M \_\_\_\_\_ Y \_\_\_\_\_

**Submitted For: (Owner)**

Name \_\_\_\_\_

Address \_\_\_\_\_

City \_\_\_\_\_ Prov. \_\_\_\_\_

Postal Code \_\_\_\_\_

Phone ( ) \_\_\_\_\_ Fax ( ) \_\_\_\_\_

**By: (Contractor)**

Name \_\_\_\_\_

Address \_\_\_\_\_

City \_\_\_\_\_ Prov. \_\_\_\_\_

Postal Code \_\_\_\_\_

Phone ( ) \_\_\_\_\_ Fax ( ) \_\_\_\_\_

## INSTALLED EQUIPMENT

Water Heater make & model as designed		Throttling Valve	
Air Handler make & model as designed		Anti-scalding Valve	
Cooling Unit make & model as designed		Back Flow Prevention Valve	
Filter type and size as designed		Expansion Tank	
2 shut off valves for heating loop		Off Season Circulation Controls	
Check Valve		Other	
Drain Valve			

## Part E - SYSTEM START UP

E.1 Fill Water-Heater with water <input type="checkbox"/>	E.5 Start Air Handler <input type="checkbox"/>
E.2 Set Water-Heater at designed temperature <input type="checkbox"/>	E.6 Check Circulation Pump Operation <input type="checkbox"/>
E.3 Fill Heating Loop with water <input type="checkbox"/>	E.7 Check Circulation Fan Operation <input type="checkbox"/>
E.4 Purge Circulation Pump <input type="checkbox"/>	E.8 Label Water-Heater <input type="checkbox"/>

## HRV BALANCING

Exhaust Air Flow \_\_\_\_\_

Fresh Air Intake Air Flow \_\_\_\_\_

Back Draft Damper installed in Stale Air to Outside Duct

## Part F - SYSTEM COMMISSIONING

Total Heat Loss \_\_\_\_\_ Btu/h      Air Handler: output \_\_\_\_\_ Btu/h      Eff. Water-Heater output \_\_\_\_\_ Btu/h

Air Handler ESP: \_\_\_\_\_ ins. W.C.      Air Flow rate: \_\_\_\_\_ CFM      Fan speed \_\_\_\_\_

Supply Water temp.: \_\_\_\_\_ °F      Return Water temp.: \_\_\_\_\_ °F      Supply Air temp.: \_\_\_\_\_ °F      Return Air temp.: \_\_\_\_\_ °F

F.1 Supply Water Temp. _____ °F <i>(measured)</i>	F.6 Required Supply Air Temperature _____ °F (F.4 + F.5)
F.2 Air Handler Output at F.1 Condition _____ Btu/h	F.7 Returned Water Temperature _____ °F <i>(measured)</i>
F.3 Air Handler Operating CFM _____ CFM <i>(measured)</i>	F.8 Water Temperature Difference _____ °F (F.1 - F.7) (min. 20 F)
F.4 Return Air Temperature _____ °F <i>(measured)</i>	F.9 Actual Supply Air Temperature _____ °F <i>(measured)</i>
F.5 Required Air Temperature Difference _____ °F (F.2 ÷ (F.3 x 1.08))	F.10 Anti-Scald Valve Outlet Temperature (if present) _____ °F <i>(measured)</i>



# CAUTION

Electrical control panel service by electrician only. Disconnect electrical supply prior to servicing. Improper wiring may result in damage to this unit. Use copper supply wires.

# ATTENTION

Entretien du panneau de contrôle électrique par un électricien seulement. Coupez l'alimentation électrique avant de procéder à l'entretien. Un câblage inadéquat pourrait endommager cet appareil. Utilisez des câbles de cuivre

## Standard Motor CAF/Air Handler Wiring Diagram

## Schéma de câblage d'un moteur de FAP/Appareil de traitement de l'air standard

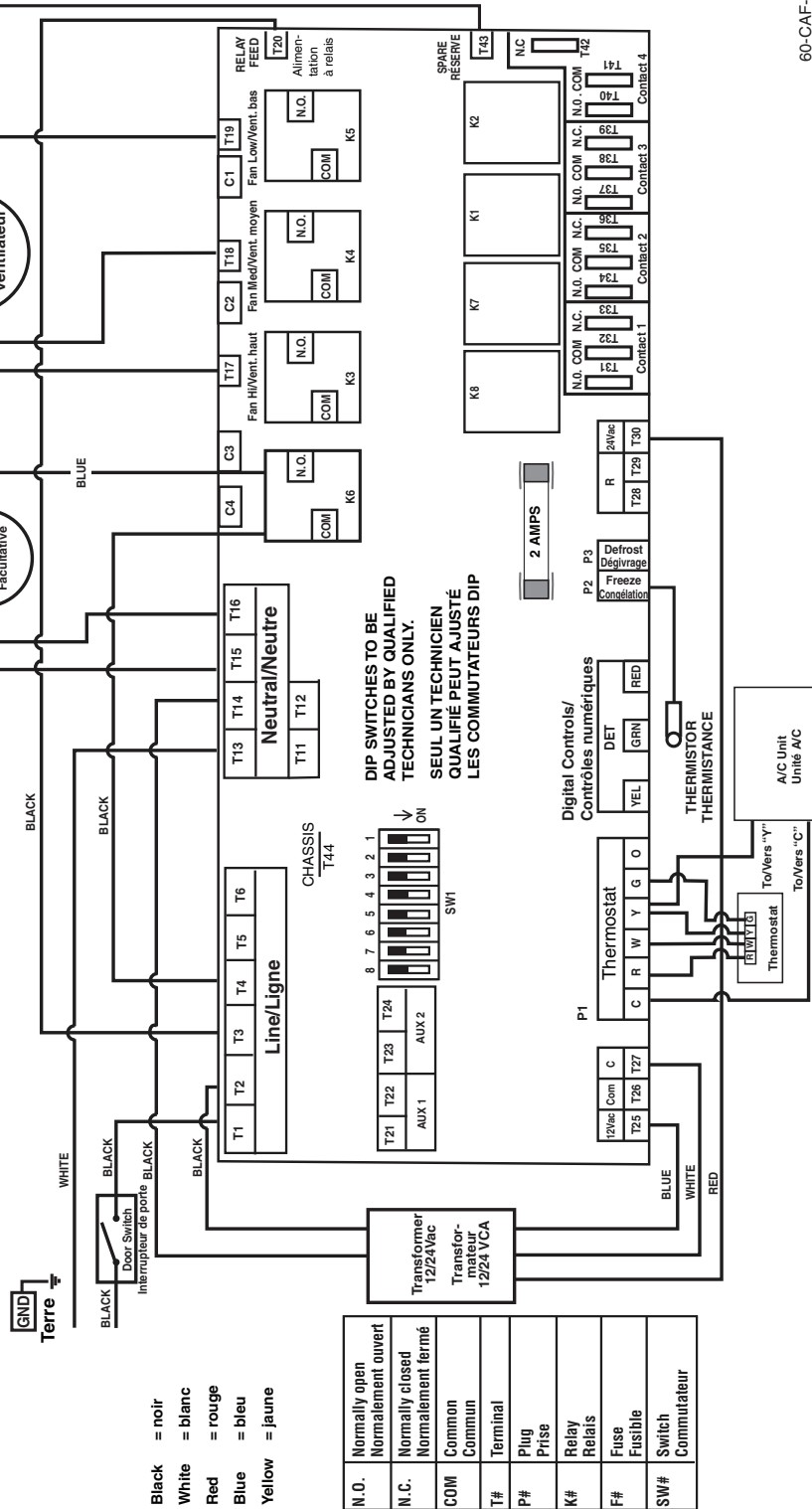

60-CAF-AH-01

# WARNING

Do not initiate power before plumbing is commissioned.

**CAUTION** ⚠

Electrical control panel service by electrician only. Disconnect electrical supply prior to servicing. Improper wiring may result in damage to this unit. Use copper supply wires.

**ATTENTION** ⚠

Entretien du panneau de contrôle électrique par un électricien seulement. Coupez l'alimentation électrique avant de procéder à l'entretien. Un câblage inadéquat pourrait endommager cet appareil. Utilisez des câbles de cuivre.

**WARNING** ⚠

Do not initiate power before plumbing is commissioned.

**ECM - CAF/Air Handler  
Wiring Diagram/  
Schéma de câblage  
FAP/Appareil de  
traitement de l'air -  
moteur à commutation  
électronique ECM**

- Black = noir
- White = blanc
- Red = rouge
- Blue = bleu
- Yellow = jaune
- Tan = havane
- Purple = pourpre
- Brown = brun

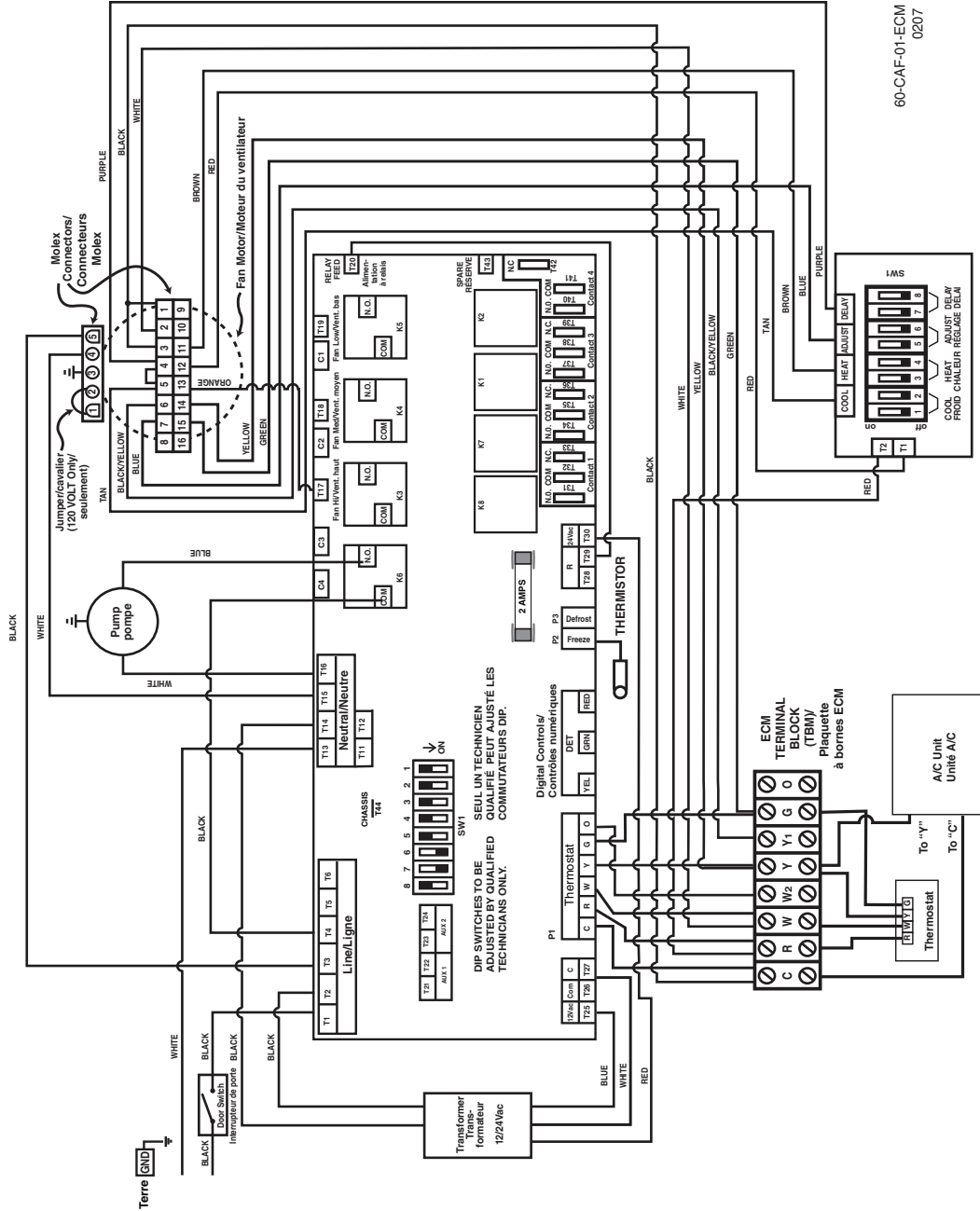

N.O.	Normally open	Normalement ouvert
N.C.	Normally closed	Normalement fermé
COM	Common	Commun
T#	Terminal	
P#	Plug	
K#	Relay	
F#	Fuse	
SW#	Switch	



69-CAF

031016